



NESCO® American Harvest®

JET-STREAM OVEN™

Recipes & Instructions

JET STREAM OVEN™

Recipes & Instructions

Congratulations on the purchase of your new Jet-Stream Oven! With it you will experience the thrill and excitement of being one of the first pioneers in a new era of food preparation.

Your Jet-Stream Oven represents a major state-of-the-art advancement in cooking. It is the “next generation” in oven technology. Its uniquely patented features are designed to give you excellence in all your cooking results in a fraction of the time.

We hope that you will find this book a helpful guide in learning to use your new Jet-Stream Oven. It was prepared with you, our valued customer, in mind.



If you have a question we would be happy to answer it. If you have a problem, we want to hear about it. For assistance call our Customer Satisfaction number 1-800-288-4545 or contact us through our website at www.nesco.com.



Executive Editor
Curt Drumm

Editor/Creative Director
Sheree Weston

Home Economist
Altanette Autry

Cover/Appetizer
Photo Courtesy of
Anchor Food Products, Inc.

\$9.95 Value

Nesco American Harvest Corporation
1700 Monroe St.
Two Rivers, WI 54241
1-800-288-4545
www.nesco.com

300-03501

© 1999 Nesco American Harvest Corporation
All Rights Reserved, including the right of
reproduction in whole or part.

YOUR WARRANTY AND SERVICE SATISFACTION

Limited One Year Warranty

This warranty applies to Nesco/American Harvest® appliances that were purchased for personal or household use. This warranty is not available to commercial purchasers or owners.

We warrant that your appliance will be free of defects in materials or workmanship, under normal home use, for a period of one year from the date of purchase. To assure proper handling of your warranty without delay, and to facilitate verification of the original date of purchase, we suggest that you complete and return the enclosed warranty registration card immediately.

Should your appliance prove to be defective within the warranty period, we will have the option to repair or replace your appliance at no charge. Transportation and/or shipping costs are not included in the terms of this warranty.

This warranty will be void if malfunction is caused by accident, misuse, negligence, including tampering, abuse, damage in transit, or use for commercial purposes. It does not cover damage incurred due to servicing at a service center other than Nesco/American Harvest, or damage caused by anything other than a manufacturing defect.

This warranty excludes any relief for incidental or consequential damages. Some states do not allow limitations on how long an implied warranty lasts or the exclusion or limitation of incidental or consequential damages, so the above limitation may not apply to you.

This warranty gives you specific legal rights, you may also have other rights which may

vary from state to state.

Your new appliance comes equipped with numerous safety features. Any attempt to interfere with the operation of these safety features makes this warranty null and void. In the event we receive an appliance for service that has been tampered with, we reserve the right to restore it to its original state and charge for the repair.

Five Easy Steps to Satisfaction

Should you have a problem with your Jet-Stream Oven, please refer to these steps for help:

1. Call us on our toll free number, 1-800-288-4545, and tell us about your problem.
2. If we instruct you to send us all or part of your appliance for repair or replacement, the Customer Satisfaction representative will give you an authorization number. This number notifies our receiving department to expedite your repair. Pack your unit carefully in a sturdy carton to prevent damage. Any damage caused in shipping is not covered by the warranty.
3. Print your name, address and authorization number on the carton.
4. Write a letter explaining the problem. Include the following: your name, address, and a copy of the original bill of sale.
5. Paste the sealed envelope containing the letter inside the carton. Insure the package for the value of the Jet-Stream Oven and ship prepaid to:

Nesco/American Harvest Corporation
1700 Monroe St.
Two Rivers, WI 54241



TABLE OF CONTENTS

Introduction 1

Warranty and Service 2

Important Safeguards 4

Important Operating Instructions 5-7

Parts Diagram & Glossary of Terms 8

Helpful Hints 9-10

Before you Begin 11

Use and Care 12-13

Let's Get Started 14-15

Appetizers and Snacks 16-25

Cooking Guide for Convenience Foods 17

Tips for Preparing Convenience Foods 21

Entrees 24-36

Cooking Guide for Meats 37

Vegetables 38-43

Cooking Guide for Vegetables 40

Baked Goods 44-55

Cooking Guide for Baked Goods 55

Quick Combos 56-61

Index 62-63

IMPORTANT SAFEGUARDS/ READ ALL INSTRUCTIONS

1. For household use only. Do not use the Jet-Stream Oven™ for other than intended use.
2. Do not touch hot surfaces.
3. Do not place on or near hot electric or gas burners, or in heated oven.
4. To protect against electrical hazards do not immerse the fan assembly, cord or plug in water or other liquid. Do not use outdoors.
5. Close supervision is necessary when any appliance is used by or near children.
6. Unplug from outlet when not in use and before cleaning. Allow to cool before putting on and taking off parts.
7. Do not clean with metal scouring pads. Pieces may break off of the pad and touch electrical parts, creating risk of electric shock.
8. Do not operate any appliance with a damaged cord or plug, after the appliance malfunctions, or has been damaged in any manner. Return appliance to the nearest authorized service facility for examination, repair or adjustment.
9. Use Accessory attachments recommended by the appliance manufacturer only.
10. Do not let cord hang over edge of table or counter, or touch hot surfaces.
11. Use extreme caution when removing hot trays or racks, also when moving an appliance containing hot oil or other hot liquids.
12. Always plug cord into the wall outlet before turning the machine on. To disconnect, turn switch to “OFF” before removing plug from wall outlet.
13. This appliance has a polarized plug (one blade is wider than the other). As a safety feature, this plug will fit in a polarized outlet only one way. If the plug does not fit fully in the outlet, reverse the plug. If it still does not fit, contact a qualified electrician. Do not attempt to defeat this safety feature.
14. If you have a countertop made of glass, Corian® or stone, set your Jet-Stream Oven on a cutting board, hot pad or trivet when cooking. The heat generated from some cooking appliances may damage these types of counter tops.

Short Cord Instructions-

A short power supply cord is provided to reduce the risk resulting from becoming entangled in or tripping over a longer cord. Extension cords may be used if care is exercised in their use. If an extension cord is used, the marked electrical rating of the cord should be at least as great as the electrical rating of the appliance. The longer cord should be arranged so that it will not drape over the table top where it can be pulled on by children or tripped over accidentally.

SAVE THESE INSTRUCTIONS

IMPORTANT OPERATING INSTRUCTIONS

Model JS-3500T

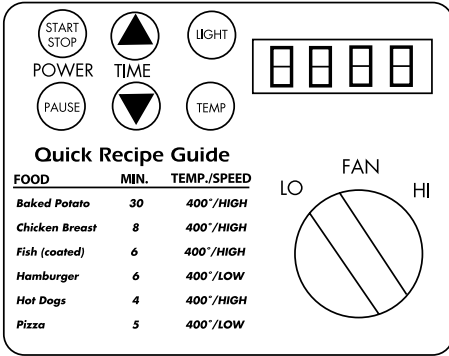

A. Activating your Oven

1. Make sure the lid is securely fastened to the fan assembly
2. Plug the oven cord into an outlet.
3. If you need to cancel out the settings or reprogram your oven, press and hold the START/STOP button for 4 seconds. This will clear all settings.

B. Setting the Fan Speed

1. Turn the Fan Speed Dial to the desired speed of LOW or HIGH (the fan speed can be changed any time during cooking)

C. Setting the Temperature

1. The default temperature of 400° is displayed in the window when you press the TEMP button.
2. To change the temperature, push the TEMP button once for 375°, twice for 350°, 3 times for 325°, 4 times for 300°, 5 times for 200°. Pressing the button one more time will bring it back to 400°.

D. Using the Lights

1. Push the light button to turn lights on and off.

E. Setting the Timer

1. Use the up and down arrows to set the timer to the desired

cooking time. Press the START/STOP button to start cooking. The oven will automatically shut off when the time is up. The display will show a “d” for counting down the remaining time, and the remaining number of minutes.

2. If you do not program in a time, it will start cooking when you press the START/STOP button, and the timer will count the minutes up from zero. The display will show a “u” when counting up. The unit will run for 4 hours or until you stop it.

F. Start, Stop or Pause the Oven

1. To begin the cooking process, press the START/STOP button.
2. To stop the oven during the cooking process, press the PAUSE button or lift the lid.
3. To stop the oven permanently, press and hold the START/STOP button for 4 seconds or until it beeps.
4. The Jet-Stream Oven features two switches that turn the oven off when the lid is opened. To resume cooking, lower the lid and press Start. If your oven does not turn on when you press START/STOP, make sure the base and powerhead are assembled correctly.
5. When the oven is done cooking, it will beep several times to let you know it's done, then continue to beep at 1 minute intervals to remind you.

NOTE: Your JS-3500T Jet-Stream Oven microprocessor is programmed to continuously monitor line voltage and temperature. If the oven stops and displays “Err” followed by a number, reset the time and temperature, then press start. (The fault may be due to a brief interruption in power that you may not notice). If the error messages become frequent, there may be some fault with the oven such as overheating. Please return your power head to an authorized service center to have it checked.

Model 3000T

with digital quartz timer

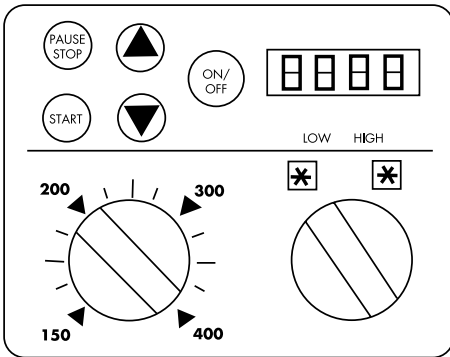

A. Turning the Oven on

1. Plug oven cord into outlet. The oven will beep twice and Display will blink (00).
2. If the oven is not programmed within 10 seconds the Display will shut itself off.
3. Pressing the Timer Increase or Timer Decrease pads will turn the display back on (display will shut off after 20 seconds if the start pad isn't pressed).

B. Setting the Fan Speed

1. Turn the Fan Speed Dial to the desired speed of LOW or HIGH (the fan speed can be changed any time during cooking).

C. Setting the Temperature

1. Turn the Temperature Dial to the desired temperature setting (the temperature can be changed at any time during cooking).

D. Untimed Cooking

1. Set the temperature and fan speed to the desired settings and press the Start Pad.
2. The oven will start and the Display will begin from (00) and count up to 120 minutes.
3. Unless you stop the oven, it will run for 120 minutes and then shut off.

E. Timed Cooking

1. Set the temperature and fan speed to desired settings.
2. Set the timer by pressing the Timer Increase and Timer Decrease pad until the desired number of minutes shows on the display (holding down the pads will cause the numbers to increase/decrease faster).
3. Press the Start Pad. The oven will run until the set time has elapsed and the display has counted down to (00). The oven will then beep three times and shut off.

Pressing ▲ (up Button) will cause the display to start at (00) and count up to 120 minutes.

Pressing ▼ (down button) will cause the display to start at (120) minutes and count down to (00).

Note: Timer can be changed during cooking but not when oven is paused. Timer will continue to beep until either the stop pad is pressed, or the lid is opened.

F. Using the Lights

1. Press the Light Pad to turn lights on and off (when the oven lid is open, the Light Pad doesn't work).

G. Stopping and Pausing the Oven

1. To pause the oven during the cooking process, press the Stop/Pause Pad once or lift the oven lid (the display will show the remaining cooking time). To restart the oven again, close the lid and press the Start Pad and the timer will resume.
2. To stop the oven and clear the display, press the Stop/Pause Pad twice. If desired, you may now enter a new cooking time and restart the oven.

Model JS-1500

Quick Recipe Guide

<i>Food</i>	<i>Min.</i>	<i>Speed</i>
<i>Baked Apples</i>	9	High
<i>Chicken Breast</i>	8	High
<i>Cookies</i>	5	Low
<i>Fish (Coated)</i>	6	High
<i>French Fries</i>	8	High
<i>Hamburger</i>	8	Low
<i>Hot Dogs</i>	4	High
<i>Pizza</i>	8	Low
<i>Waffles</i>	4	Low

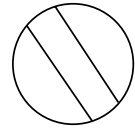
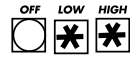

A. Turning the Oven on

1. Make sure the lid is securely fastened to the fan assembly.
2. Plug the oven cord into an outlet.
3. Turn the Fan Speed Dial to the LOW or HIGH position to begin cooking.

B. Setting the Fan Speed

1. Turn the Fan Speed Dial to the desired speed of LOW or HIGH (the fan speed can be changed any time during cooking)

C. Stopping the Oven

1. Turn the Fan Speed Dial to the OFF position.
2. Lifting the lid during cooking will stop the fan. Lowering the lid will start the fan again.



PARTS DIAGRAM AND GLOSSARY OF TERMS

- 1. Fan Assembly** - houses the mechanical components of the oven.
- 2. Light bulbs** (on some models)
- 3. Space washer** - keeps the fan blade distanced from the fan assembly.
- 4. Fan blade** - spins at 4000 rpm to cook food quickly
- 5. Space washer** (on some models)
- 6. Lock washer** - allows a snug fit of the fan blade.
- 7. Wing nut** - secures fan blade to the fan assembly.
- 8. Lid** - see-through dome of the cooking enclosure.
- 9. Top/Hold-down rack** - serves as a "hold-down" rack for light weight foods and at times may be used as a second cooking level.
- 10. Bottom rack** - upper and lower positions offer 2 levels of cooking.

- 11. Hinge pin assembly**
connects to both the fan assembly and handle/leg of base. Provides a hinge when lifting the lid.
- 12. Non stick liner** - prevents the base from reaching undesired temperatures. Allows easy cleanup.
- 13. Base** - bottom of the cooking enclosure.

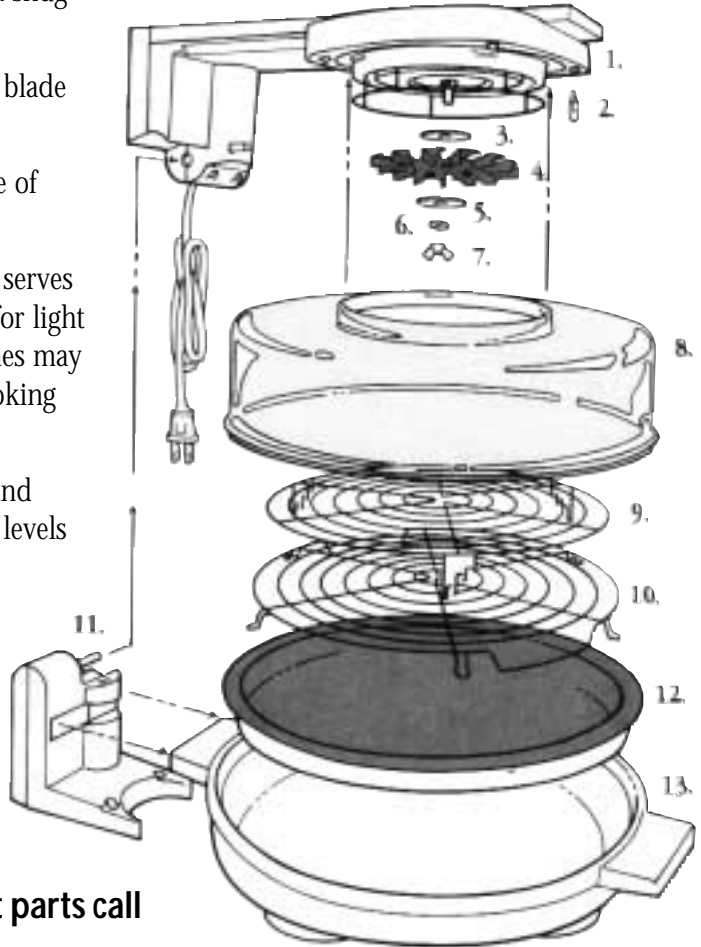

To order replacement parts call
1-800-288-4545.

HELPFUL HINTS

Using the Racks

- The top rack is usually used as a hold down rack when cooking small or lightweight foods.
- Unless otherwise specified, when two racks are shown, food should be contained or sandwiched between the top and bottom racks.
- When baking small items, use a foil-wrapped rack that is pierced with a few holes.
- Always place food directly on bottom rack unless otherwise specified.
- Use the bottom rack upper position, as a rule, when following your own recipe.
- When cooking individual items i.e. baked potatoes or chicken fillets, arrange around outside of rack. Group lightweight foods together.
- Spraying rack with non stick spray will make cleanup even easier. (Do not spray the lid.)
- When preheating, remove bottom rack. Place food on rack while oven is heating, then replace quickly to prevent heat loss.

Caring for Your Fan Blade

- Check fan blade periodically for flatness by spinning it on a flat surface. Bent or warped blades will cause vibrating and/or unusual noise. Gentle adjusting by pushing down on the blade (while on a hard, flat

surface) should correct any problems. If a blade is severely bent and cannot be realigned, call our toll free number for assistance.

Preheating

- If a recipe calls for preheating, always preheat at 400°HIGH for 2 minutes.

Cooking Semi-Liquids

- Start at LOW speed until surface is firm enough to prevent movement.

Cooking Bacon

- Cook on LOW speed and use caution when preparing bacon to avoid steam burns when lifting the lid.
- When cooking bacon and eggs, put bacon on bottom rack and cover with top rack (upside down and flat) and place eggs on top rack.

Using Cookware

- Use caution when using cookware i.e. pizza pans with lightweight objects. Use the top/hold down rack to add extra weight and eliminate danger of pans levitating and causing damage to fan.

Determining Cooking Times

- Use the cooking times in both the charts and recipes as a guide. Variables in food size and thickness, humidity, altitude and your personal preference for doneness all have bearing on actual cooking times.

Cooking Baked Products

- Do not preheat when cooking baked products.

- A 12 inch pizza pan with a hole in the center works very well for cooking baked products. Call Customer Satisfaction for details (800-288-4545).

Automatic Shut-off

- The unit shuts off automatically upon lifting the lid. Lift lid slowly to prevent liner from lifting and grease splattering out.

Using Foil

- Poke a few holes in foil to allow air to circulate for better heating.

Serving

- When your food is finished cooking, detach the lid and hinge pin assembly, and use the base as a serving dish. Be careful, as the unit will be hot!

Storage

- Stand the unit upright to sit vertically on your counter top, under your cupboards and out of the way.

Converting Recipes

As a rule of thumb:

- Temperature will be the same
- Recipes calling for 425-475° use 400°
- Time will be $\frac{1}{3}$ to $\frac{1}{2}$ less than recipe time
- Experiment with fan speed - many foods will set on LOW and once set can be finished on HIGH.

Roasting Chicken

- Roast first half of cooking time with breast down and turn breast up for second half.

Cooking Meat

- As an option, lightly coat thin meats

with melted margarine or cooking oil to aid browning.

Baking Frozen Pizza

- For best results, cover pizza with top rack at level 1.
- For crispier crust cut hole in center
- To decrease time, cut large pizza in half before cooking.

Fig. A

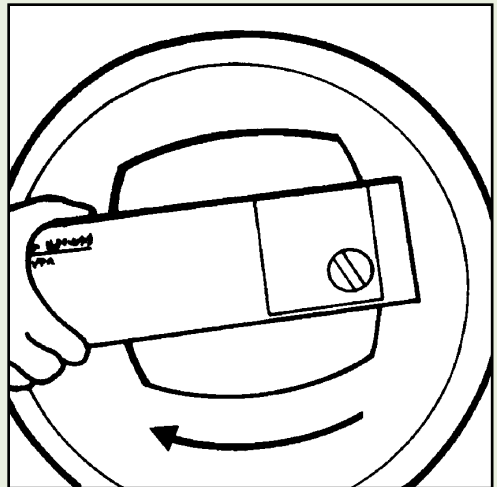
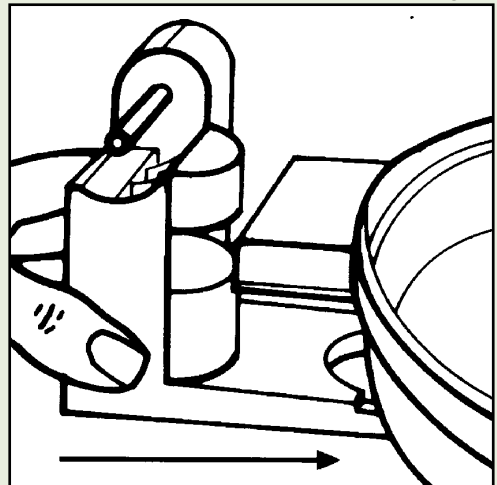

Fig. B



BEFORE YOU BEGIN

Preparing Your Unit

- Before using your Jet-Stream Oven™ for the first time wash base, liner, lid and racks in hot soapy water or run through the dishwasher. **IMPORTANT - do not put fan assembly in water.**

- For best results, and longevity of your liner and non stick racks cure before using. Brush a light coating of vegetable oil on the surfaces and then run unit empty at 400° HIGH for three minutes. **IMPORTANT - do not brush oil on lid.**

Assembling the Oven

- Notice that the lid (#8 pg. 8) has 4 nibs that correspond to 4 L-shaped ridges (bayonette slots) in the fan assembly (#1). They allow a snug, precision fit and all 4 must be securely locked together to prevent the lid from releasing during use. You must take care to assure that the lid is squared with the fan assembly. We suggest you lay the lid on a flat surface and insert the fan assembly into the opening. Press gently until the fan slides all the way in and turn clockwise until locked into place. Check for proper fit by jiggling the assembly, there should be no movement. The collar should be the same all the way around. If your machine does not close properly, the lid is probably not on straight, remove it and repeat the procedure. (see fig. A & page 10)

- Snap hinge pin assembly (#11) over handle and leg of base (#13) as shown. Then, insert the handle of the base into

slot in Hinge Pin Assembly. Note: If done correctly, one of the base's handles will be covered or hidden by the hinge pin assembly (see fig. B page 10)

- Slide fan assembly (#1) onto silver hinge pin (#11) until firmly in place (see fig. C page 11).

- Place liner (#12) in base of unit (#13) and bottom rack (#10) on liner (#12). **Never operate unit without using the liner (#12) as it may cause damage to your counter top or other surface.**

- Lower lid (#8) onto bottom base (#13). Make sure lid is closed and seated properly in the base. Check to see that the fan is in the "OFF" position and plug into electrical outlet.

- Place unit far enough away from wall to assure free flow of air. Clear away any objects on the counter top that may obstruct airflow to the back of the unit.

- You are now ready to cook in your new Jet-Stream Oven!

Fig. C

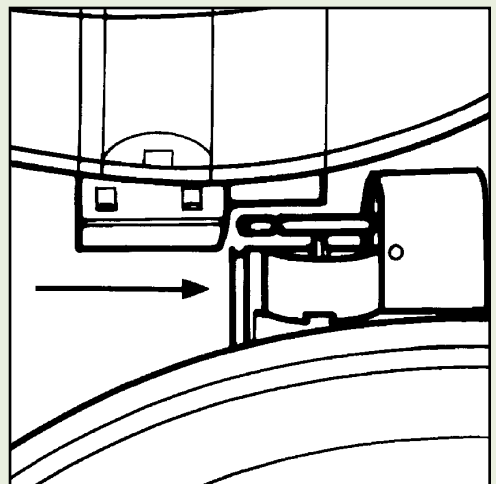

USE AND CARE

Your Jet-Stream Oven™ is made of space age plastics, which are not only capable of withstanding high temperatures, but are also stain resistant and easy to care for. To keep your Jet-Stream Oven looking new and functioning properly, it is important to follow the care instructions below.

Protect the Non Stick Surfaces

For best results, use rubber, plastic or wooden utensils on the surface of the liner. Metal objects may cause damage to the surface. Plastic scrubbing pads may be used to remove baked on residue.

Never use non stick spray on the lid, it will become gummy and very difficult to remove without damaging the surface.

Using the Liner

Your Jet-Stream Oven comes equipped with a removable liner. The liner not only makes cleanup a snap but doubles as a heat shield, keeping the bottom of the unit from reaching undesired temperatures. Always use the liner to prevent damage to counter top or other surfaces.

Never Restrict Airflow

The motor is located at the back of the fan assembly. It is important to keep the counter clear behind the unit, to allow free flow of air to the motor.

Replacing the Bulbs (not on all units)

Your Jet-Stream Oven comes with 4 bulbs to enhance the visibility of your food while cooking. These are long-life and should not burn out for an extended period of time. If a bulb does

burn out, all 4 will go dark because they are wired in a series. Replacement bulbs are available, free of charge, for units still under warranty. See the warranty section of this manual for information and warranty procedures.

Voltage Drop in Older Homes

In older homes you may experience a drop in power, or blow a fuse or circuit breaker, if the unit is run simultaneously with another high-wattage appliance such as a toaster or microwave oven. This is due to the limited amount of current available in older kitchens with 15 amp service and is a common problem with all high-wattage appliances.

Cleaning

Your Jet-Stream Oven is made of durable easy care plastics. Cleanup is quick and easy. Disassemble oven before washing. Every part of your Jet-Stream Oven, except the power head, can be washed on the **top rack** of the dishwasher. Drying cycle must be on "Off" or "Energy Saver." (Note: dishwasher may leave film on metal parts which can be undesirable.) DO NOT use rinsing agents in your dishwasher, they may deteriorate the plastic. On occasion, it may become necessary to soak parts that have burned-on foods or greasy film in hot soapy water. Do not use abrasive metal cleaning pads or cleanser, they will scratch the polished surfaces.

The Lid and Base

Easy-Off® oven cleaner, cold method, can be used on both the lid and base when soaking is not effective.

Should stubborn stains occur in the base, remove by soaking in a solution of ½ cup liquid bleach and 4 cups of water or use “dip-it®” coffee pot cleaner. DO NOT use any spray cleaners.

The Liner Pan and Racks

Plastic mesh scrubbing pads may be used on the wire cooking racks for baked on foods. The chrome finish on the racks and nonstick finish on the liner pan should not require more than soaking in hot soapy water to remove stubborn stains. Do not use Easy Off® on nonstick metal surfaces.

Light Wash/Pre wash

Use this method for light cleaning jobs or as a pre-wash to make clean-up easier for heavy cleaning followed by hand washing. Place top rack in liner pan, place bottom rack on top, pour ½ tsp. dish washing liquid into liner pan, add ½ cup of warm water, close lid, set temperature control at 150° and fan on low. Let run for 5-10 minutes.

Disassemble oven, rinse thoroughly to remove all cleaning residue, and dry.

For heavy cleaning jobs, use method above as a pre-wash to make clean-up easier, followed by hand washing. If a lot of grease has collected in the liner pan during cooking, wipe out grease with paper towels before using this cleaning method. Disassemble oven, rinse thoroughly to remove all cleaning residue, and dry.

The Fan Assembly

The fan assembly requires little maintenance because there is seldom

the occasion for it to get soiled. In the event that it requires cleaning, the same precautions must be taken for cleaning it as are taken for the liner and racks (never use abrasive cleaning pads, cleansers or Easy Off).

To disassemble the fan for cleaning, unplug from the AC outlet, remove the wing nut and any washers and then the fan blade, taking care not to bend it (See Fig. D). Wash the blade in hot soapy water, rinse and dry. Wipe the rest of the assembly with a hot soapy dish cloth, using care not to get water inside the unit. Rinse with clean damp cloth. **Do not immerse the powerhead in water!**

Before reattaching the fan blade check for flatness by spinning it on a flat surface. “Gently” correct any problems by pushing down on the blade while on a hard, flat surface. If the blade is severely bent and cannot be realigned, call our toll free number for assistance.

Reattach the fan blade. Take care to return washers to their proper location and securely fasten the wing nut (see Fig. D).

Note: Any other servicing should be performed by an authorized service representative.

Fig. D

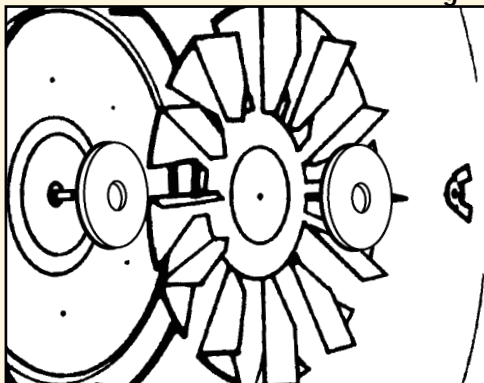

LETS GET STARTED

To save time, cut large dense foods into smaller pieces.

Although large items such as a whole chicken will cook up beautifully, it will take more time than chicken cut into pieces because there is less surface area available. For example, a whole chicken baked in a conventional oven would take about 2 hours. In the Jet-Stream Oven™, it would take 40 minutes, or 1/3 the time. Chicken pieces in an oven would be done in about 60 minutes. In the Jet-Stream Oven they would take 15-20 minutes, or 1/4 the time.

Utilize the adjustable racks for optimum results.

The Jet-Stream Oven comes with 2 adjustable racks which allow maximum airflow around the food. The size and consistency of the food being prepared determines the appropriate level and/or combination of racks to use.

The bottom rack offers a reversible upper/lower position. The top/hold down rack is adjustable to 3 different levels to accommodate different thicknesses of food. The top rack also serves as a hold-down rack for lightweight foods. Rack placement is given for all recipes in this book, see Guidelines at a Glance™ on next page.

When placed directly on the rack, food is cooked on both sides at once without turning! All cookware suitable for oven

and range top is also suitable for the Jet-Stream Oven (microwave cookware should not be used unless the manufacturer states that it is oven safe). Some recipes in this book call for a 12 inch pizza pan. This specifically refers to a pan that has no rim or handles and measures a maximum of 12 to 12¼ inches across. In some instances the same result may be achieved by wrapping the bottom rack tightly with heavy duty aluminum foil.

Cook a whole meal at once.

One of the nicest features of your new Jet-Stream Oven is it's ability to prepare an entire meal simultaneously in one cooking enclosure, which washes up easily in the dishwasher. See our "Quick Combo's™" section on page 50 for some creative combinations and then create some of your own!

Use accessory expander rings when a larger capacity is needed.

Don't limit the benefits of the Jet-Stream Oven to just the small jobs. With accessory expander rings you can even roast a 12lb. turkey in 1 and 3/4 hours vs. 4 hours in your conventional oven!

Check with your local retailer or our Customer Satisfaction Department for availability.



Follow the Guidelines at a Glance™ instructions

In the recipe sections of this book you will find a quick reference guide for preparing each recipe. It contains all the detailed information you will need for success, including rack use. Study the example below to familiarize yourself with the components of the chart and you will see just how easy it is!

Guidelines at a Glance

PREHEAT	TEMP	FAN SPEED	TIME	RACK USE	YIELD
YES	400°	HIGH	5-6 MIN.		4

1. 2. 3. 4. 5. 6.



1. Preheat - YES or NO depending on the recipe. If yes, preheat at 400° HIGH for 2 minutes, then adjust to recipe temperature.

2. Temp - refers to the temperature setting. Turn the temperature dial until the arrow on the top corresponds to the desired temperature.

3. Fan Speed - indicates fan speed setting, which is either HIGH or LOW.

4. Time in min. - the time is always given in minutes.

5. Rack use - refers to the position of the racks for preparing each recipe.

 bottom rack- upper position
 bottom rack- lower position

The top/hold down rack is adjustable to 3 levels.

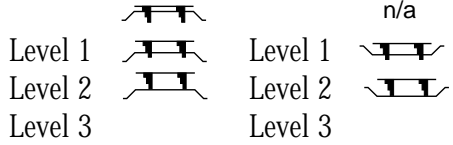



Unless otherwise specified, when two racks are shown in a recipe, food should be contained or “sandwiched” in between the top and bottom racks. Note that the top rack is only used in conjunction with the bottom rack and never alone.

6. Yield - number of servings or individual pieces.

In recipes with 2 steps, the Guidelines at a Glance chart will have 2 sets of instructions. In the example below, note that the steps are numbered in the pre-heat box. The numbers correspond to the steps referenced in the body of the recipe. Follow the instructions for each step

Guidelines at a Glance

PREHEAT	TEMP	FAN SPEED	TIME	RACK USE	YIELD
1. YES	400°	HIGH	5-6 MIN.		
2. NO	350°	LOW	20-25 MIN.		4-6

according to the chart.





















APPETIZERS / SNACKS

Good news hors d'oeuvres lovers! The Jet-Stream Oven™ makes large quantities of melt-in-your-mouth appetizers in just minutes! It's perfect for parties because the cooking process is visually entertaining. Your guests will enjoy watching their food transform before their eyes and delight in the taste.

In addition to the following recipes, and any you may have of your own, you will find many frozen appetizers that will cook up better than you've ever tasted before. Follow the same guidelines referenced in the convenience section for preparing packaged foods.

COOKING GUIDE FOR CONVENIENCE FOODS

ITEM	QTY.	PRE-HEAT	TEMP/SPEED	TIME	RACK USE	HELPFUL HINTS
Boneless Marinated Chicken breasts	2 (5 oz. ea.)	YES	400° HIGH	6-8 MIN.		Wipe off excess Marinade
Wieners in Wraps	5 (1-2 oz. ea.)	NO	375° HIGH	5-6 MIN.		
FROZEN						
Battered shrimp	12-16 oz. pkg	YES	400° HIGH	5-7 MIN.		
Breaded Cheese Nuggets or sticks	10 ½ oz. pkg.	YES	400° HIGH	4-5 MIN.		
Breaded Chicken Patties	4 (2 ½- 3 oz. ea.)	YES	400° HIGH	5-7 MIN.		
Breaded Fish Fillets	4 (2-2½ oz. ea.)	YES	400° LOW	6-8 MIN.		
Buttered Fish Fillets	4 (2-3 oz. ea.)	NO	375° LOW	10-12 MIN.		
Chicken Fillets	4 (3¾ oz. ea)	YES	400° HIGH	7-10 MIN.		
Egg Rolls	7 ¼ oz. pkg.	YES	400° LOW	4-5 MIN.		
French Bread Pizza	12½ oz. pkg.	NO	375° LOW	8-10 MIN.		
Fried Chicken	4 pcs. 8 pcs.	NO NO	375° High 375° High	10-12 MIN. 12-14 MIN.		Place smaller pieces in cntr.
Pocket Sandwiches	2	NO	375° LOW	6-8 MIN.		
Microwave Sausage Patties or links	4 8	NO NO	400° LOW 400° LOW	3-4 MIN. 4-5 MIN.		Pierce links with fork.
Mini Quiches	8 ½ oz. pkg.	YES	375° HIGH	4-5 MIN.		
Pizza	1 (9 or 10")	YES	pkg. temp LOW	½- ⅔ conv. time		Light ingredients may fly around
Pot Pie	1 (7-8 oz. ea.)	YES	400° LOW	16-20 MIN.		Cut slits in top crust
Sandwich Croissants	2 (4 ½ oz. ea.)	NO	350° LOW	10-12 MIN.		
Waffles or French toast	4 squares	NO	400° LOW	3-4 MIN.		

Unless specified, when two racks are shown, food should be sandwiched between the top and bottom racks.

Arrange small items in circle around edge of rack.



MINI MEXICAN MEATBALLS

- 1 pound lean ground beef
- 1 (1¼ oz.) package taco seasoning mix
- Bottled salsa or picante sauce

Thoroughly blend seasoning mix into ground meat. Shape into meatballs about 1¼ to 1½ inch in diameter and place directly on rack. Bake according to guidelines until well browned. Serve with salsa.

Guidelines at a Glance

PREHEAT	TEMP	FAN SPEED	TIME	RACK USE	YIELD
YES	400°	LOW	5-6 MIN.		20-24

MINI FRANKS

- 1 pound package cocktail franks
- 2 refrigerated pie crusts

Roll pie crust slightly to create a square shape and cut into 24 2-inch squares. Repeat with second crust. Place a frank on each square and fold over opposite corners; press to seal.

Place fold side down directly on rack and cook according to guidelines until browned. Repeat with second batch. Serve hot with mustard or ketchup.

Guidelines at a Glance

PREHEAT	TEMP	FAN SPEED	TIME	RACK USE	YIELD
YES	400°	HIGH	6-7 MIN.		48



SPICY CHICKEN DRUMMETTES

- 20 chicken drumettes
- 3 tablespoons soy sauce
- 2 tablespoons hot pepper sauce (increase amount for spicier drumettes)

Dip

- ¾ cup light sour cream
- 2 tablespoons minced green onion
- ¾ teaspoons soy sauce

Combine soy sauce, hot sauce and drumettes in a zip top bag. Marinate in refrigerator for 1-2 hours. Mix Dip and Chill.

Remove chicken from marinade and drain. Place ½ the chicken drumettes on each rack and cook according to guidelines until done.

Guidelines at a Glance

PREHEAT	TEMP	FAN SPEED	TIME	RACK USE	YIELD
NO	400°	HIGH	8-10 MIN.		20

BARBECUED SHRIMP

- 1 pound raw peeled and deveined shrimp
- Barbeque sauce

Thread raw shrimp on 6 inch bamboo skewers and brush with barbecue sauce. Place shrimp on rack and cook according to guidelines until shrimp are pink.

Guidelines at a Glance

PREHEAT	TEMP	FAN SPEED	TIME	RACK USE	YIELD
YES	400°	LOW	4-5 MIN.		8

CREAM CHEESE WONTONS

12 wonton wrappers

3 oz. package cream cheese

oil

Cut cream cheese into 12 blocks, place one block in center of each wonton wrapper. Moisten edge of wonton wrapper, fold in half and press to seal. Brush wontons lightly with oil. Place on rack and cook according to guidelines until golden brown. Serve with hot mustard or sweet-sour sauce.

Guidelines at a Glance

PREHEAT	TEMP	FAN SPEED	TIME	RACK USE	YIELD
YES	400°	HIGH	3-4 MIN.		12

ORIENTAL KABOBS

1 lb. large raw shrimp, peeled and deveined

1 lg. bell pepper, cut into 1 inch chunks

8 oz. can pineapple chunks, drained

1/3 cup sweet and sour sauce

12 - 6 inch bamboo skewers

Thread shrimp, peppers and pineapple chunks on 6 inch skewers. Brush with sweet and sour sauce and place on rack. Grill according to guidelines until shrimp are pink.

Guidelines at a Glance

PREHEAT	TEMP	FAN SPEED	TIME	RACK USE	YIELD
YES	400°	HIGH	4-6 MIN.		12

EGG ROLLS

3 cups shredded cabbage

1 cup minced celery

1 cup bean sprouts

1/2 cup shredded carrots

1/2 lb. cooked pork loin, trimmed of fat and cut into thin strips

3 tablespoon Hoisin sauce

12 egg roll wrappers

2 teaspoon flour

2 teaspoon water

3 tablespoon oil

1/4 teaspoon Oriental hot oil

Drop vegetables into boiling water. Cook for 10 seconds; drain. Combine vegetables, pork and Hoisin sauce. Place 1/12th of mixture in center of each egg roll wrapper. Fold one corner over filling, then fold over two outside corners. Combine flour and water to make paste; brush on edges. Fold remaining corner over roll and press to seal. Combine oils and brush over egg rolls. Air fry according to guidelines.

Guidelines at a Glance

PREHEAT	TEMP	FAN SPEED	TIME	RACK USE	YIELD
YES	350°	HIGH	8-10 MIN.		12





Oriental Kabobs & Egg Rolls

TIPS FOR PREPARING CONVENIENCE FOODS

- When package calls for preheating, set temperature at 400° HIGH for 2 minutes.
- Set heat control to temperature stated on the package and cook for about $\frac{1}{3}$ to $\frac{1}{2}$ the conventional time. Use 400° when package calls for 425° or 450°.
- Use the top and bottom racks together to contain or sandwich small or light weight foods in between them.
- When preparing frozen “TV” dinners containing 2-4 foods:
- Do not use plastic covers intended only for microwave oven use; replace plastic film with foil.
- Cover portions that contain ingredients with low moisture content, such as rice and vegetables, with foil, (punch holes in top of foil).
- Cover meals that are in a sauce base with foil (punch holes in top of foil).
- Expose meats for optimum heating and browning.
- Place dinner on bottom rack in lower position and secure with top rack in second position.
- Dinners generally require $\frac{1}{2}$ the conventional time.
- When heating frozen pot pies, first cut 2-3 slits in top crust.

PIZZA SNACKS

18 melba toast rounds

3 oz. (½ of a 6 oz. can) tomato paste

1-2 teaspoons Italian seasoning

18 pepperoni slices

¼ cup grated Parmesan cheese

Spread a teaspoonful of tomato paste on each melba toast round; sprinkle with Italian seasoning. Top with a slice of pepperoni and sprinkle with Parmesan cheese; place directly on rack.

Bake according to guidelines until hot.

Guidelines at a Glance

PREHEAT	TEMP	FAN SPEED	TIME	RACK USE	YIELD
YES	400°	HIGH	2-3 MIN.		18

HOT SHRIMP APPETIZERS

4 slices bread, crusts removed and cut into quarters

Margarine or butter

1 (4¼ oz.) can broken shrimp, rinsed and drained

⅓ cup mayonnaise or whipped dressing

1 tablespoon pickle relish

2 teaspoons onion, finely minced

½ teaspoon lemon juice



Paprika

Step 1. Spread bread squares with margarine or butter and place directly on rack. Toast according to guidelines until lightly browned.

Step 2. Combine shrimp, mayonnaise, pickle relish, onion and lemon juice.

Place a teaspoon of shrimp mixture on one side of each bread square. Continue cooking according to guidelines until brown and bubbly. Sprinkle with paprika. Serve hot.

Guidelines at a Glance

PREHEAT	TEMP	FAN SPEED	TIME	RACK USE	YIELD
1. YES	400°	HIGH	2-3 MIN.		
2. NO	400°	LOW	3-4 MIN.		16

ITALIAN ARTICHOKE DIP

1 (9 oz.) pkg. frozen artichoke hearts, thawed

1 cup no-fat sour cream

3 tablespoons grated Parmesan cheese

2 tablespoons dry onion soup mix

¼ teaspoon black pepper

Paprika

Vegetable sticks

Combine artichoke hearts, sour cream, Parmesan cheese, onion soup mix and pepper in food processor or blender. Process until smooth. Pour into greased 1 quart casserole. Sprinkle lightly with paprika. Bake according to guidelines until heated through. Serve with fresh vegetable sticks.

Guidelines at a Glance

PREHEAT	TEMP	FAN SPEED	TIME	RACK USE	YIELD
NO	350°	HIGH	12-14 MIN.		2.5 Cups



GRILLED CHEESE TOMATO ROUNDS

Thin 12 inch loaf French bread (approx. 3" wide) cut into 1" slices

12 tomato slices (2 tomatoes)

½ pound medium cheddar cheese, sliced thin

Italian seasonings



Salt and pepper to taste

Toast bread in oven according to guidelines. Remove from oven and lightly butter. Place a tomato slice in the center of each slice of toasted bread. Lightly salt and pepper. Top with cheese and sprinkle with Italian seasonings.

Spray rack with no stick coating. Place rounds on rack 6 at a time. Broil according to guidelines.

Repeat for remaining 6 rounds.

Guidelines at a Glance

PREHEAT	TEMP	FAN SPEED	TIME	RACK USE	YIELD
1. NO	400°	LOW	1-2 MIN.		
2. NO	400°	LOW	3-4 MIN.		12

SALAMI PINWHEELS

1 pound frozen bread dough, thawed

8 oz. pkg. cream cheese, softened

3 (4 oz.) pkg. salami

1 tablespoon minced dried onion

1 teaspoon dried basil

Roll or stretch dough into a rectangle 10" x 15". Spread cream cheese over dough; sprinkle with basil and onion and lay salami on top. Starting with the

15" side roll up like a jelly roll. Pinch seam to seal and cut into 12 pieces. Preheat oven 400°. Turn oven off and quickly place pinwheels in liner pan (no racks) and close lid. Turn oven to 400° for 30 seconds and turn off. Let pinwheels raise until double in size about 15 minutes. Bake according to guidelines.

Guidelines at a Glance

PREHEAT	TEMP	FAN SPEED	TIME	RACK USE	YIELD
1. YES	400°	HIGH	½ MIN.	NONE	
2. NO	OFF	OFF	15 MIN.	NONE	
3. NO	400°	LOW	8-10 MIN.	NONE	12

MARINATED CHICKEN WINGS

2 pounds of chicken wings, tips removed

Marinade

¼ cup lemon juice

¼ cup olive oil

1 teaspoon lemon pepper

½ teaspoon garlic powder

2 teaspoons soy sauce

Cut wings apart at joint. Combine ingredients for marinade; place marinade and wings in a large zip top bag, zip the bag closed removing as much air as possible. Turn bag several times to coat wings. Refrigerate at least 2 hours or overnight.

Place half the wings on each rack and grill according to guidelines.

Guidelines at a Glance

PREHEAT	TEMP	FAN SPEED	TIME	RACK USE	YIELD
NO	400°	HIGH	8-10 MIN.		36



CROSTINI WITH MOZZARELLA

1 lg. tomato, seeded and finely chopped (about 1 cup)

1 cup shredded Mozzarella cheese (4 oz.)

1 tablespoon olive oil

1 teaspoon minced fresh basil

¼ teaspoon balsamic or red wine vinegar

⅛ teaspoon salt

⅛ teaspoon pepper

12 slices French bread, ½ inch thick

Combine all ingredients, except bread, and mix well. Spread mixture on bread slices and place on rack. Cover with upper rack and bake according to guidelines until crisp. Serve immediately.

Guidelines at a Glance

PREHEAT	TEMP	FAN SPEED	TIME	RACK USE	YIELD
YES	400°	HIGH	5-6 MIN.		12

RUMAKI

10 slices bacon, cut in half

10 water chestnuts, cut in half

5 chicken livers, cut in quarters or pineapple pieces

¼ cup soy sauce

2 tablespoons brown sugar

Wrap a water chestnut and a chicken liver or pineapple piece in each piece of bacon; secure with a toothpick. Marinate in soy sauce and brown sugar for 2-4 hours; drain and place on rack. Broil according to guidelines until bacon is crisp.

Guidelines at a Glance

PREHEAT	TEMP	FAN SPEED	TIME	RACK USE	YIELD
YES	400°	HIGH	9-12 MIN.		20

OLIVE CHEESE SNACKS

- 1 (5 oz.) jar bacon cheese spread**
- 3 tablespoons margarine or butter, softened**
- Dash of worcestershire sauce**
- $\frac{2}{3}$ cup all-purpose flour**
- 36 small stuffed green olives**
- $\frac{1}{4}$ teaspoon baking powder**

Blend cheese and margarine or butter together until light and fluffy. Add seasoning and worcestershire sauce, mix well. Stir in flour and baking powder, mix to form a dough. Shape around olives using 1 teaspoon of dough for each. Place on ungreased pizza pan.

Bake according to guidelines until golden brown. Serve hot with mustard.

Guidelines at a Glance

PREHEAT	TEMP	FAN SPEED	TIME	RACK USE	YIELD
YES	400°	LOW	6-8 MIN.		36

SPINACH STUFFED MUSHROOMS

- 6 oz. frozen spinach soufflé (half of a 12 oz. package)**
- $\frac{1}{4}$ cup dried bread crumbs**
- $\frac{1}{2}$ cup shredded cheddar or Swiss cheese**
- $\frac{1}{4}$ teaspoon garlic salt**
- $\frac{1}{8}$ teaspoon pepper**
- 10-12 large fresh mushrooms**

Remove spinach soufflé from package and cut in half with sharp knife. Wrap half in foil and return to freezer; thaw remaining half at room temperature or in

microwave on defrost setting for 2-4 minutes. Stir in bread crumbs, cheese, garlic salt and pepper. Rinse mushrooms and remove stems. Chop stems and add to spinach mixture. Stuff mushroom caps and place in flat baking dish.

Bake according to guidelines until lightly browned on top.

Guidelines at a Glance

PREHEAT	TEMP	FAN SPEED	TIME	RACK USE	YIELD
YES	400°	LOW	4-5 MIN.		10-12

SPICY PEPPER SNACKS

- 1 (3 oz.) pkg. cream cheese**
- $\frac{1}{2}$ cup shredded low fat cheddar cheese**
- 2 tablespoons chopped green chilies**
- 2 tablespoons chopped ripe olives**
- 1 teaspoon minced onion**
- 5 drops hot pepper sauce**
- 8 oz. can refrigerated crescent dinner rolls**

Combine all ingredients except rolls. Separate dough into 4 rectangles, sealing perforations. Spread $\frac{1}{4}$ mixture on each rectangle and roll up jelly roll style. Cut each into 10 slices. Place cut side down on Jet-Stream Oven cookie-pizza pan or on greased foil-wrapped rack. Bake according to guidelines until golden brown.

Guidelines at a Glance

PREHEAT	TEMP	FAN SPEED	TIME	RACK USE	YIELD
NO	375°	LOW	6-8 MIN.		40



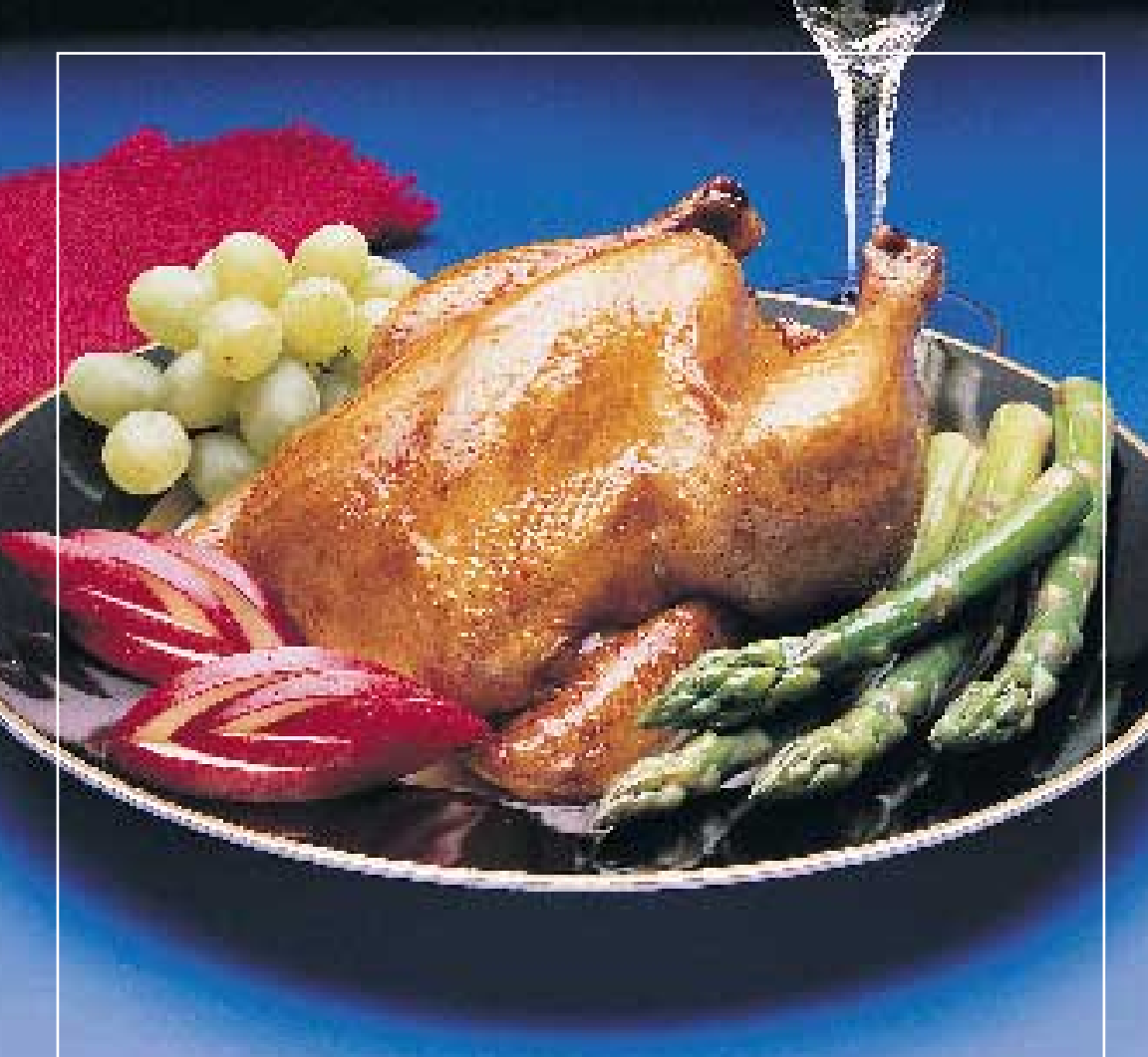

ENTREES

Your new Jet-Stream Oven™ is perfect for meats. The “Cyclonic Cooking™” action quickly sears in juices allowing the outside to brown while the inside stays moist. In addition to the exceptional taste, the Jet-Stream Oven takes the effort out of preparation. There is no turning, because both sides broil or grill at once. Because the cooking process is entirely enclosed there is no spattered grease, messy broiler pans or charred grills to clean.

The Jet-Stream Oven cooks food so quickly that there is a tendency to actually over cook, especially with meats. Use the times given as a guide and adjust them according to your own preference for doneness.

STUFFED CORNISH GAME HENS

3 (18 oz.) Cornish game hens

Packaged stuffing or your own recipe

1/3 cup margarine or butter, melted



Wash and dry Cornish game hens. Fill cavities with stuffing. Tie legs together, tuck wing tips under. Place directly on rack. Brush with melted margarine or butter.

Step 1. Cook according to guidelines.

Step 2. Turn fan speed down according to guidelines and continue cooking until tender.

Note: For 2 hens, reduce second cooking time by 5-6 minutes. For 4 hens increase second cooking time by 3-4 minutes.

Guidelines at a Glance

PREHEAT	TEMP	FAN SPEED	TIME	RACK USE	YIELD
1. YES	375°	HIGH	12 MIN.		
2. NO	375°	LOW	12-15 MIN.		3

BROILED SALMON

Marinade

1 teaspoon dried thyme leaves

1/4 teaspoon garlic powder

2 tablespoons lime juice

1/2 teaspoon salt

1/4 teaspoon fresh ground pepper

1 tablespoon olive oil

4 salmon steaks

Combine marinade ingredients and salmon steaks in gallon size zip top bag. Refrigerate 30 minutes. Spray rack with

non-stick coating. Place salmon steaks on rack with the thickest part toward the edge of rack. Grill according to guidelines.

Guidelines at a Glance

PREHEAT	TEMP	FAN SPEED	TIME	RACK USE	YIELD
NO	400°	HIGH	10-12 MIN.		4

SAUSAGE BROCCOLI ROLL-UPS

1 pound frozen bread dough, thawed

1 pound sausage, cooked drained and finely crumbled

1 pound frozen chopped broccoli, thawed and drained

1 tablespoon dried minced onion

8 ounces cream cheese, softened

1 cup medium cheddar cheese, shredded

Roll dough into a 15" x 10" rectangle. Spread cream cheese over dough; sprinkle onion over cream cheese and top with broccoli, sausage and cheese. Starting at the long side, roll up jelly roll fashion, pinch seam to seal and cut into 12 pieces.

Preheat oven for 2 minutes. Turn off fan, quickly place roll-ups in liner pan and close lid. Turn oven to 400° for 30 seconds then turn oven off. Let roll-ups raise until double in size, about 15 minutes. Bake according to guidelines. Serve plain or with hot mushroom soup (not diluted).

Guidelines at a Glance

PREHEAT	TEMP	FAN SPEED	TIME	RACK USE	YIELD
1. YES	400°	HIGH	1/2 MIN.	NONE	
2. NO	OFF	OFF	15 MIN.	NONE	
3. NO	400°	LOW	8-10 MIN.	NONE	12

DUCKLING L'ORANGE

1 (5 lb.) duckling

1/2 small onion

1/2 small apple

1 teaspoon dried rosemary

Salt and pepper to taste

Sauce

1/2 cup orange juice

1/3 cup packed brown sugar

2 teaspoons grated orange peel

Dash salt

1 tablespoon orange juice



2 teaspoons cornstarch

Step 1. Assemble Jet-Stream Oven with one Expander Ring. Place onion and apple in duck cavity; sprinkle in rosemary, salt and pepper. Place duck, breast side down, on rack coated with no-stick spray. Cook according to guidelines.

Step 2. Turn duck breast side up and continue cooking according to guidelines. Prepare sauce by blending together 1/2 cup orange juice, brown sugar, orange peel and salt in saucepan. Mix together cornstarch and 1 tablespoon orange juice; stir into saucepan. Cook until mixture is thickened and clear, stirring constantly.

Remove onion and apple from duck, carve and serve with sauce.

Guidelines at a Glance

PREHEAT	TEMP	FAN SPEED	TIME	RACK USE	YIELD
1. YES	350°	HIGH	30 MIN.		
2. NO	350°	LOW	30-40 MIN.		4

CHINESE CHICKEN STIR-FRY

3/4 lb. boneless, skinless chicken breasts

1 large red bell pepper

1 medium onion

1/2 lb. pea pods, tips and strings removed

1 cup bean sprouts

1 tablespoon oil

1/4 cup sweet and sour sauce or glaze

Step 1. Cut chicken and pepper into 1/4 inch strips; cut onion into 1/4 inch slices. Combine chicken, pepper, onion, pea pods, bean sprouts and oil in liner pan. Cook according to guidelines.

Step 2. Stir in sauce and continue cooking until chicken is done and vegetables are tender crisp. Serve over rice with additional sauce, if desired.

Guidelines at a Glance

PREHEAT	TEMP	FAN SPEED	TIME	RACK USE	YIELD
1. YES	400°	HIGH	3 MIN.	NONE	
2. NO	400°	HIGH	3-4 MIN.	NONE	4



PORK & RED CHILI STIR-FRY

- ¾ lb. lean boneless pork loin, cut into ¼ inch slices**
- ¾ lb. fresh green beans, cut into 2 inch lengths OR one 10 oz. pkg. frozen cut green beans, thawed**
- 1 tablespoon vegetable oil**
- 2 cloves garlic**
- 2 teaspoons sugar**
- 2 teaspoons soy sauce**
- 1½ teaspoons fresh chopped chili peppers OR ½ teaspoon crushed dried red pepper**
- 1 teaspoon sesame oil**
- 1 teaspoon rice vinegar**
- 1 teaspoon minced fresh ginger**

Place pork and green beans in zip top bag. Combine remaining ingredients; pour into bag and shake until pork and green beans are well coated. Pour into liner pan and cook according to guidelines.

Serve over cooked rice, if desired.

Guidelines at a Glance

PREHEAT	TEMP	FAN SPEED	TIME	RACK USE	YIELD
YES	400°	HIGH	6-7 MIN.	NONE	4



Pork & Red Chili Stir Fry

CRAB CAKES

- 12 oz. fresh cooked crab meat or 2 (6 oz.) cans, well drained
- 1 egg, beaten
- ¼ cup low-fat mayonnaise
- 1 teaspoon Worcestershire sauce
- ½ teaspoon prepared mustard
- ¼ teaspoon pepper
- 1 cup soft bread crumbs
- Cracker crumbs or dried bread crumbs

Combine egg, mayonnaise, Worcestershire sauce, mustard and pepper until well blended. Stir in bread crumbs. Lightly fold in crab meat. Shape mixture into 4 patties about ¾" thick. Coat all side with crumbs. Bake according to guidelines. Serve with cocktail sauce, if desired.

Guidelines at a Glance

PREHEAT	TEMP	FAN SPEED	TIME	RACK USE	YIELD
YES	400°	HIGH	9-10 MIN.		4

CHICKEN CORDON BLEU

- 4 boneless chicken breast halves, pounded thin
- 4 (1 oz.) thin slices cooked ham
- 4 (1 oz.) thin slices cheese, Swiss, cheddar or mozzarella
- Cooking or olive oil
- Dried bread crumbs

Top each chicken breast with ham and cheese. Roll up and secure each with toothpicks. Brush lightly with oil and roll in bread crumbs. Place roll-ups

directly on rack. Cook according to guidelines until done.

Guidelines at a Glance

PREHEAT	TEMP	FAN SPEED	TIME	RACK USE	YIELD
YES	350°	LOW	8-10 MIN.		4

MUSTARD ROSEMARY CHICKEN



- 4 chicken breast halves
- 6 tablespoons olive oil
- 3 cloves garlic, peeled and crushed
- 2 tablespoons lemon juice
- 2 tablespoons prepared mustard
- 1 teaspoon dried rosemary
- Salt and pepper to taste

Mix together all ingredients except chicken in shallow casserole. Coat both sides of chicken with mixture. Cover and marinate in refrigerator overnight.

Step 1. Remove chicken breasts from marinade; drain and place directly on rack. Cook according to guidelines until brown.

Step 2. Turn temperature down according to guidelines and continue cooking until done.

Guidelines at a Glance

PREHEAT	TEMP	FAN SPEED	TIME	RACK USE	YIELD
1. YES	400°	HIGH	6 MIN.		
2. NO	350°	LOW	12-15 MIN.		4



HONEY-MUSTARD CHICKEN LEGS

7-9 (2 pounds) chicken legs

¼ cup margarine or butter

¼ cup honey

2 tablespoons prepared mustard

2 tablespoons fresh lemon juice



¼ cup sesame seeds

Melt margarine or butter in saucepan. Stir in honey, mustard and lemon juice; mix well. Pour over chicken legs in 2-quart casserole. Cover and let marinate for several hours or overnight.

Step 1. Remove chicken legs from marinade; drain and sprinkle with sesame seeds. Place on rack and cook according to guidelines.

Step 2. Turn temperature down according to guidelines and continue cooking until done.

Guidelines at a Glance

PREHEAT	TEMP	FAN SPEED	TIME	RACK USE	YIELD
1. YES	400°	HIGH	5 MIN.		
2. NO	375°	LOW	8-10 MIN.		4

ROASTED TURKEY BREAST

1 (1½-2 pound) turkey breast half

¼ cup margarine, melted or cooking oil



Salt and pepper to taste

Step 1. Brush turkey breast with margarine or oil. Season with salt and pepper. Place bone side down on rack. Cook according to guidelines.

Step 2. Turn temperature down

according to guidelines and continue cooking until done, basting twice during cooking. A thermometer placed in thickest area should read 190°F. Let turkey breast stand for 15 minutes before slicing.

Guidelines at a Glance

PREHEAT	TEMP	FAN SPEED	TIME	RACK USE	YIELD
1. YES	400°	HIGH	5-6 MIN.		
2. NO	350°	LOW	20-25 MIN.		4-6

CRISPY CHICKEN STRIPS

1 pound boneless chicken breasts, cut into ½ to ¾ inch wide strips

1 egg, beaten

3 tablespoons margarine or butter, melted

1 teaspoon worcestershire sauce (optional)

Salt and pepper to taste

Cracker crumbs

Sweet and sour sauce, chili or other sauce (optional)

Mix together egg, margarine and worcestershire sauce in pie plate. Add salt and pepper to taste. Dip chicken strips in mixture, then coat with crumbs. Place chicken strips directly on rack. Cook according to guidelines until strips are browned and crisp. Serve with sauce.

Guidelines at a Glance

PREHEAT	TEMP	FAN SPEED	TIME	RACK USE	YIELD
YES	400°	HIGH	5-8 MIN.		4





Chicken & Barbecued Baby Back Ribs

BARBECUED BABY BACK RIBS

- 3 lbs. pork baby back ribs**
- 1 cup barbecue sauce**

Assemble Jet-Stream Oven with one expander ring. Cut ribs into serving size sections and place half on each rack. Grill 15 minutes. Brush ribs with sauce, turn fan to high and grill 8-9 minutes more.

Guidelines at a Glance

PREHEAT	TEMP	FAN SPEED	TIME	RACK USE	YIELD
NO	400°	LOW/HIGH	23 MIN.		5

BARBECUED CHICKEN

- 1 (3 lb) chicken, quartered**
- 1/4 teaspoon each salt & pepper**
- 3/4 cup barbecue sauce**

Spray rack with non stick spray. Arrange chicken on rack with thinner parts toward center of rack. Grill 15 minutes. Brush chicken on both sides with sauce, turn fan speed to low, grill 10-12 minutes more.

Guidelines at a Glance

PREHEAT	TEMP	FAN SPEED	TIME	RACK USE	YIELD
YES	400°	HIGH/LOW	25-27 MIN.		4

WIENERSCHNITZEL

- ¾ lb. boneless veal slices**
- ⅓ cup seasoned flour**
- 1 egg, beaten**
- 3 tablespoons margarine or butter, melted**
- 2 cups soft, fresh white bread crumbs**
- 2 tablespoons fresh lemon juice**
- Lemon slices, opt.**

Flatten veal to about ¼ inch thick and coat with seasoned flour. Combine egg and melted margarine or butter in flat dish; dip veal slices in mixture. Coat veal with bread crumbs and press into veal; sprinkle with lemon juice. Place on rack and grill according to guidelines until lightly browned. Serve with lemon slices if desired.

Guidelines at a Glance

PREHEAT	TEMP	FAN SPEED	TIME	RACK USE	YIELD
NO	400°	LOW/HIGH	23 MIN.		5

STROMBOLI

- 1 (1 lb.) loaf frozen bread dough, thawed**
- 1 small onion, sliced**
- ½ small red bell pepper, sliced**
- ½ small green bell pepper, sliced**
- 1 tablespoon olive oil**
- ¼ lb. thinly sliced hard salami**
- ¼ lb. shredded mozzarella cheese**
- ¼ lb. shredded mild cheddar or colby cheese**
- 1 egg, beaten with 1 tablespoon water**

Roll bread dough into a 12" x 16" rectangle. Sauté vegetables in olive oil over

medium-high heat in a sauté pan. Layer vegetables, meats and cheeses over dough. Roll up beginning with short side; brush edges and ends with beaten egg mixture and pinch to seal. Place roll on foil-covered rack, seam side down, curving to resemble a crescent. Brush top with beaten egg mixture. Bake according to guidelines until well browned.

Guidelines at a Glance

PREHEAT	TEMP	FAN SPEED	TIME	RACK USE	YIELD
YES	400°	HIGH/LOW	25-27 MIN.		4

ITALIAN BEEF STIR-FRY

- ¾ lb. beef sirloin steak, cut into ⅛ inch thick slices**
- 3 small zucchini, thinly sliced (about 2 cups)**
- 1 tablespoon olive oil**
- 2 cloves garlic, minced**
- ½ teaspoon black pepper**
- 1 cup cherry tomato halves**
- ¼ cup reduced-calorie Italian salad dressing**
- 2 cups hot cooked spaghetti**
- 1 tablespoon grated parmesan cheese**

Combine steak strips, zucchini slices, oil, garlic and pepper in zip top bag. Shake well to evenly coat. Pour into liner pan and stir-fry 4-5 minutes. Stir in tomato halves and Italian dressing; cook 1-2 minutes longer. Serve beef mixture over hot spaghetti; sprinkle with parmesan cheese.

Guidelines at a Glance

PREHEAT	TEMP	FAN SPEED	TIME	RACK USE	YIELD
YES	400°	HIGH/LOW	25-27 MIN.		4

DELUXE BREADED FISH

3-4 (4 oz.) white fish fillets

¼ cup mayonnaise or salad dressing

½ cup cracker crumbs

Salt and pepper to taste

Spread both sides of fish fillets with mayonnaise and season with salt and pepper. Coat with cracker crumbs and place directly on rack. Bake according to guidelines until fish flakes easily.

Guidelines at a Glance

PREHEAT	TEMP	FAN SPEED	TIME	RACK USE	YIELD
YES	400°	HIGH	5-6 MIN.		3-4

CORNMEAL BATTERED FISH

3-4 (4 oz.) walleye or

other white fish fillets

1 egg

3 tablespoons margarine or

butter, melted

Cornmeal

Salt and pepper to taste

In pie plate beat egg with margarine until well blended. Add salt and pepper to taste. Dip fillets in egg mixture and then coat with cornmeal. Place fillets directly on rack. Bake according to guidelines until fish flakes easily.

Guidelines at a Glance

PREHEAT	TEMP	FAN SPEED	TIME	RACK USE	YIELD
YES	400°	HIGH	4-6 MIN.		3-4

ENGLISH PASTRY

2 refrigerated pie crusts

**24 ounce can of beef stew, or your
homemade favorite**

Unfold pie crust on a floured cutting board. Cut crust in thirds. Roll each third into a 5 ½-6 inch circle. Divide stew into 6 portions and place off center on pastry circles. Wet edges of circle with water, fold pastry over stew and press edges with a fork to seal well. Spray rack with no-stick coating. Slide pastries from cutting board onto rack. Bake according to guidelines.

Guidelines at a Glance

PREHEAT	TEMP	FAN SPEED	TIME	RACK USE	YIELD
NO	400°	HIGH	10-12 MIN.		6

MINI MEATLOAVES

1 pound ground beef

1 egg, slightly beaten

¼ cup onion, chopped

¼ cup soft bread crumbs

¼ cup ketchup or bar-b-que sauce

Salt and pepper to taste

Mix ingredients together. Divide into 4 parts and shape each into an oval loaf about ¾- inch thick and place directly on rack. Cook according to guidelines until done.

Guidelines at a Glance

PREHEAT	TEMP	FAN SPEED	TIME	RACK USE	YIELD
YES	400°	LOW	12-14 MIN.		4

STUFFED CHEESEBURGERS

- 1 pound ground beef
- 1 small onion, minced
- 4 thin slices cheese
- Salt and pepper to taste

Divide meat into 8 parts; flatten into very thin patties. Season half of patties with salt and pepper and top with minced onion and cheese slice. Cover with remaining patties and pinch edges together to seal. Place patties directly on rack.

Broil according to guidelines until done.

Guidelines at a Glance

PREHEAT	TEMP	FAN SPEED	TIME	RACK USE	YIELD
YES	400°	LOW	4-6 MIN.		4

SHRIMP KABOBS

- 16-20 large shrimp, peeled
- 12 each small fresh mushrooms, cherry tomatoes, pineapple chunks, green pepper squares
- 1/4 cup bottled sweet and sour sauce

Thread shrimp and other ingredients on 4 metal or bamboo skewers. Place directly on rack and brush with bottled sauce. Cook according to guidelines.

Serve on a bed of rice.

Guidelines at a Glance

PREHEAT	TEMP	FAN SPEED	TIME	RACK USE	YIELD
YES	400°	LOW	4-5 MIN.		4

ORIENTAL BEEF STRIPS

- 3/4 pound thinly sliced beef, sirloin tip or round steak

Marinade

- 1/3 cup soy sauce
- 2 tablespoons sugar
- 1 tablespoon cooking oil
- 1 large clove garlic, minced
- 1 1/2 teaspoon curry powder
- 1/2 teaspoon black pepper

Mix together marinade ingredients. Place beef slices in flat casserole or pie plate; add marinade and stir to coat all sides. Cover and marinate for 1 hour. Thread beef strips onto 4-6 metal or bamboo skewers. Place on rack and broil according to guidelines until done.

Guidelines at a Glance

PREHEAT	TEMP	FAN SPEED	TIME	RACK USE	YIELD
YES	400°	LOW	2-4 MIN.		3-4

LEMON PEPPER CHICKEN

- 4 boneless, skinless, chicken breast halves
- 1 egg, beaten
- 1/2 cup freshly grated parmesan cheese
- 1 tablespoon lemon pepper

Combine parmesan cheese and lemon pepper; dip chicken in egg and then in parmesan mixture. Grill according to guidelines until browned.

Guidelines at a Glance

PREHEAT	TEMP	FAN SPEED	TIME	RACK USE	YIELD
YES	400°	HIGH	12-15 MIN.		4

BEEF AND PINEAPPLE KABOBS

**1 lb. boneless beef top sirloin steak,
cut 1 inch thick**

1 small onion, finely chopped

½ cup teriyaki sauce

16 1 x 1 inch chunks fresh pineapple

**1 8 oz. can whole water chestnuts,
drained**

12 - 6 inch bamboo skewers

Cut beef into ¼ inch strips. Combine onion and teriyaki sauce. Place beef strips in small bowl; add teriyaki sauce







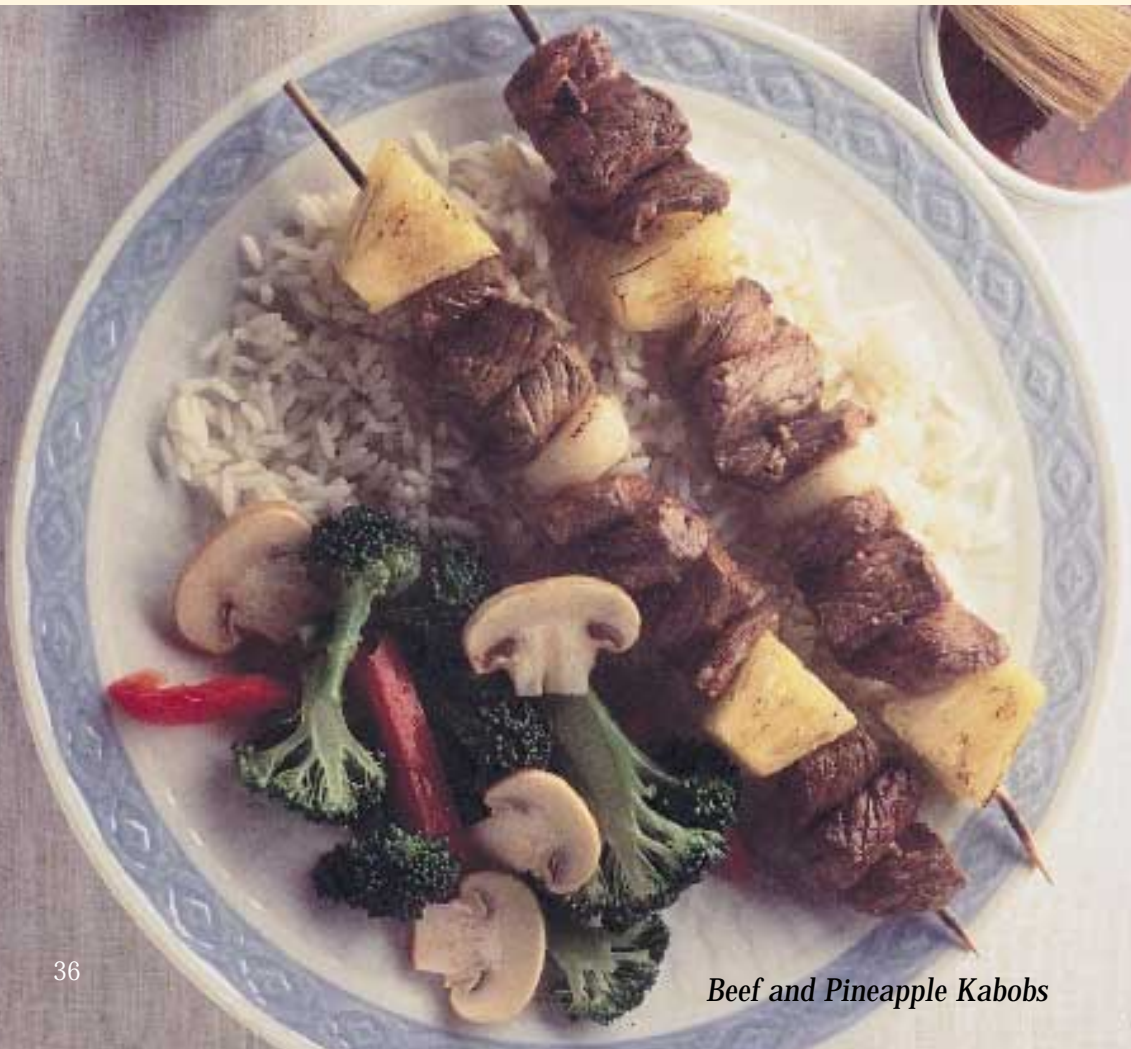







mixture and stir to coat. Alternately thread beef strips (weaving back and forth), pineapple chunks and water chestnuts onto skewers. Place kabobs on rack and grill according to guidelines.

Guidelines at a Glance

PREHEAT	TEMP	FAN SPEED	TIME	RACK USE	YIELD
YES	400°	HIGH	3 MIN.		4



COOKING GUIDE FOR MEATS

ITEM	QTY.	PRE-HEAT	TEMP/SPEED	TIME	RACK USE	HELPFUL HINTS
Bacon	6 slices	YES	400° Low	5-6 Min.		Use Caution Steam builds up
Chicken, Whole (w/ one expander ring)	1 (3-5 lbs.)	YES	1. 400° High 2. 400° Low	12-14 Min.		Turn over ½ way through
Chicken Breast with bone	2 halves (1-1 ¼ lbs.)	YES	1. 400° High 2. 350° Low	5-6 Min. 10-12 Min.		Opt.: brush w/ melted marg.
Boneless Chicken Breasts	4	YES NO	1. 400° High 2. 350° Low	6 Min. 12-15 Min.		Opt.: brush w/ melted marg.
Cornish Game Hen	1 (18 oz.)	YES	1. 375° High 2. 375° Low	8 Min. 7-8 Min.		Opt.: brush w/ melted marg.
Eggs (in the shell)	4	NO	375° Low	7-8 Min. 8-9 Min. 9-10 Min.		Soft Med Hard
Fish Fillets in Coating Mix	3-4 (4 oz. ea.)	YES	400° High	6-8 Min.		
Ground Beef Patties (Hamburgers)	2-4 (¼ lb. ea.)	YES	400° Low	5-7 Min. 6-8 Min. 7-9 Min.		Rare Med Well
Ground Turkey Patties	4-5 (¼ lb. ea.)	YES	400° Low	7-10 Min.		
Ham Steak	¾-1 lb. (½" thick)	YES	400° Low	5-6 Min.		Slash edges in 2-3 places
Italian Sausage or Bratwurst	3-4 (¾-1 lb.)	YES	400° High	10-12 Min.		Pierce with fork
Pork Chops in Coating Mix	2-4 (½" thick)	YES	400° Low	12-15 Min.		
Salmon Steaks	2 (¾-1 lb.)	YES	1. 400° Low 2. 350° Low	5 Min. 7-9 Min.		Opt. : Brush w/ melted marg.
Steak-T-bone or Porterhouse	½-1 lb. (½" thick) ½-1 lb. (¾" thick) ½-1 lb. (1" thick)	YES	400° Low	4-6 Min. 7-10 Min. 8-12 Min.		
Turkey (w/ two expander rings)	1 (12 lbs.)	YES	350° Low	1Hr.+ 45Min.		Brush w/ marg. or oil

Unless otherwise specified when two racks are shown in a recipe, food should be contained or “sandwiched” between the top and bottom racks.

After roasting whole poultry, let stand a few minutes before carving.



VEGETABLES

The Jet-Stream Oven™ offers a new and exciting technique for cooking vegetables. “Air frying” provides the crisp taste of fried foods without the grease that traditionally goes along with them. In the following recipes you will discover some interesting applications of this new process. “Jet-Stream potatoes” for example, is our equivalent to french fries-without the guilt! In addition, you can prepare your favorites in a fraction of the conventional time, or for a complete meal, combine vegetables and meat (see “Quick Combos™” section for combination ideas).



JET-STREAM POTATOES

- 4 (6 oz.) baking potatoes
- ¼ cup margarine or butter, melted
- ¼ cup grated Parmesan cheese
- Salt and pepper to taste

Cut each potato into lengthwise quarters. Brush all sides with melted margarine or butter. Sprinkle with Parmesan cheese, salt and pepper. Place potato quarters directly on rack.

Bake according to guidelines until golden brown and tender.

Guidelines at a Glance

PREHEAT	TEMP	FAN SPEED	TIME	RACK USE	YIELD
YES	400°	HIGH	15-18 MIN.		4

GRILLED SWEET POTATOES

- 2-3 (1-1½ pounds) medium sweet potatoes
- ¼ cup margarine, melted or cooking oil

Peel potatoes and cut into ½ inch diagonal slices. Place directly on rack and brush with melted margarine or cooking oil. Cook according to guidelines until browned and tender when pierced with a fork.

Guidelines at a Glance

PREHEAT	TEMP	FAN SPEED	TIME	RACK USE	YIELD
YES	400°	HIGH	10-12 MIN.		3-4

DILLED ZUCCHINI

- 2-4 medium zucchini, cut in half lengthwise
- ¼ cup margarine, melted or olive oil
- Dill weed

Place zucchini directly on rack and brush halves on both sides with melted margarine or olive oil. Sprinkle with dill weed. Grill according to guidelines until tender.

Guidelines at a Glance

PREHEAT	TEMP	FAN SPEED	TIME	RACK USE	YIELD
YES	400°	HIGH	7-11 MIN.		2-4

STUFFED BAKED POTATOES

- 2 large baking potatoes, baked and cut in half (see vegetable chart page 36)
- ⅓-½ cup milk
- 2-3 tablespoons margarine or butter
- Salt and pepper to taste
- 1 cup cheddar cheese, grated

Cut potatoes and scoop out insides leaving a ¼ inch thick shell. Mash scooped out potatoes; beat in milk, margarine or butter, salt and pepper until fluffy. Fill shells half full with mashed potatoes; top each with ¼ cup grated cheese. Pile remaining mashed potatoes on top. Place stuffed potatoes directly on rack.













Bake according to guidelines until lightly browned.

Guidelines at a Glance

PREHEAT	TEMP	FAN SPEED	TIME	RACK USE	YIELD
YES	375°	LOW	4-6 MIN.		4



COOKING GUIDE FOR VEGETABLES

ITEM	QTY.	PRE-HEAT	TEMP/SPEED	TIME	RACK USE	CONTAINER/ HELPFUL HINTS
Acorn Squash (cut in half)	1 (1 1/4 lb.)	YES	375° Low	15-20 Min.		Flat casserole cut side down
Baked Potatoes	3 (6oz.)	NO	400° High	40-45 Min.		Pierce w/ fork rub w/ oil
Zucchini (cut in half)	3-4 med.	YES	400° Low	9-12 Min.		Coat w/ marg.
Frozen: Baked Beans	14 oz.	YES	375° Low	15-18 Min.		Pkg. container*
Breaded Vegetables	12 oz.	YES	400° Low	4-6 Min.		Pizza Pan/ top rack
Corn Soufflé	12 oz.	YES	375° Low	15-20 Min.		Pkg. container*
French Fries	single layer	YES	400° Low	12-15 Min.		Pizza Pan/ top rack
Hashbrown Patties	4	YES	400° High	12-14 Min.		brush w/ oil
Onion Rings	9-10 oz.	YES	400° High	10-12 Min.		
Potatoes au Gratin	11½ oz.	YES	375° Low	14-16 Min.		Pkg. container*
Spinach Soufflé	12 oz.	YES	375° Low	15-20 Min.		Pkg. container*
Vegetable Lasagna	10 1/2 oz. 21 oz.	YES YES	375° Low 375° Low	25-30 Min. 35-40 Min.		Pkg. container* Pkg. container*
Vegetable Pouch	8-10 oz.	YES	400° High	9-10 Min.		Pierce once

Unless otherwise specified, when two racks are shown in a recipe, food should be contained or sandwiched between the top and bottom racks.

* Many packaged food items come in a cooking container, this container is perfectly safe to use in the Jet-Stream Oven.™

VEGETABLE KABOBS

12 each small fresh mushrooms, cherry tomatoes, green pepper squares, onion squares

¼ cup margarine or butter, melted and mixed with ½ teaspoon dill weed or ¼ cup bottled sweet and sour sauce

Alternate vegetables on 4 metal or bamboo skewers. Place directly on rack and brush with melted margarine or butter or with bottled sauce.

Bake according to guidelines until tender.

Guidelines at a Glance

PREHEAT	TEMP	FAN SPEED	TIME	RACK USE	YIELD
YES	400°	HIGH	3-5 MIN.		4

ORANGE ASPARAGUS

1 pound asparagus, cut into 1 ½" pieces
8 teaspoons orange juice concentrate

Divide asparagus among four pieces of foil each 12" x 12". Shape foil around asparagus forming a pouch. Add 2 teaspoons of orange juice concentrate to each pouch, seal and flatten pouches to about 1½" thick. Steam according to guidelines.

Guidelines at a Glance

PREHEAT	TEMP	FAN SPEED	TIME	RACK USE	YIELD
YES	400°	HIGH	8-9 MIN.		4

ITALIAN STUFFED TOMATOES

2 large tomatoes, halved

1 cup cooked rice

¼ cup grated Romano or mozzarella cheese

1 tablespoon melted margarine or butter

½ teaspoon parsley flakes

1 clove garlic, minced salt and pepper to taste

Hollow out tomato halves. Combine rice, 2 tablespoons cheese, margarine or butter, parsley, garlic, salt and pepper. Toss gently and fill tomatoes. Sprinkle remaining cheese over each filled tomato. Place on rack and bake according to guidelines.

Guidelines at a Glance

PREHEAT	TEMP	FAN SPEED	TIME	RACK USE	YIELD
YES	400°	HIGH	4-6 MIN.		4

Do you have a favorite recipe
you'd like to share?
Enter it on our web site at
www.nesco.com



BROILED TOMATO HALVES

- 2 medium tomatoes, cut in half crosswise
- 3 tablespoons margarine or butter, melted
- 1 tablespoon Parmesan cheese
- 1/3 cup cracker crumbs
- 1/2 teaspoon dried basil
- Garlic salt and pepper to taste

Mix together margarine or butter, Parmesan, cracker crumbs and seasonings; spoon onto tomato halves and place halves directly on rack.

Broil according to guidelines until heated thoroughly.

Guidelines at a Glance

PREHEAT	TEMP	FAN SPEED	TIME	RACK USE	YIELD
YES	400°	LOW	6-8 MIN.		4

BREADED CAULIFLOWER

- 5 cups of cauliflower florets about 1/2" pieces
- 1/3 cup melted margarine or butter
- 1/2 cup cracker meal
- 3 tablespoons Parmesan cheese
- 1/8-1/4 teaspoon red pepper

Place cauliflower in bowl, pour melted margarine or butter over and stir to coat. Place cracker meal, cheese and pepper in a zip top bag. Add cauliflower and shake to coat. Place on rack and bake according to guidelines.

Guidelines at a Glance

PREHEAT	TEMP	FAN SPEED	TIME	RACK USE	YIELD
YES	400°	HIGH	8-10 MIN.		4



ITALIAN EGGPLANT

- 1 medium eggplant, peeled and cut into 1/2 inch thick slices
- 2 tablespoons margarine or butter, melted
- 2-3 tablespoons milk
- 1 egg
- Salt and pepper to taste
- Dried bread crumbs
- Spaghetti sauce
- Thin slices of mozzarella cheese

Step 1. Mix together margarine or butter, milk, egg, salt and pepper in a flat dish. Place bread crumbs in saucer. Dip eggplant slices into liquid mixture and then coat both sides with crumbs. Place directly on rack and cook according to guidelines or until slices are tender.

Step 2. Top each slice with 3-4 tablespoons of spaghetti sauce and a thin slice of mozzarella cheese. Continue cooking according to guidelines until cheese melts.

Guidelines at a Glance

PREHEAT	TEMP	FAN SPEED	TIME	RACK USE	YIELD
1. YES	400°	HIGH	8-10 MIN.		
2. NO	400°	LOW	2-3 MIN.		4



STUFFED ZUCCHINI

- 2 large zucchini**
- 2 slices bread**
- 3 tablespoons margarine, melted**
- 3 tablespoons grated Parmesan cheese**
- Salt and pepper to taste**
- Paprika (optional)**

Cut zucchini in half lengthwise and cut out insides leaving ¼-inch shell. Place cut out zucchini and bread in food processor; process to fine crumbs. Stir in margarine, cheese, salt and pepper; mix well. Fill zucchini shells with mixture and press in place; sprinkle with paprika. Place stuffed zucchini directly on rack.

Bake according to guidelines until tender.

Guidelines at a Glance

PREHEAT	TEMP	FAN SPEED	TIME	RACK USE	YIELD
YES	400°	HIGH	7-12 MIN.		4

STUFFED ACORN SQUASH



- 1 (1 - 1¼ pound) small acorn squash, cut in half lengthwise with seeds removed**
- 4 (6 oz) ground beef, veal or lamb**
- 3-4 tablespoons dried bread crumbs**
- 1 egg**
- 1 tablespoon onion, chopped**
- ½ teaspoon dried basil**
- Salt and pepper to taste**

Step 1. Place squash halves in flat casserole, cut side down. Cook according to guidelines or until barely tender when

pierced with fork. Remove from oven.

Step 2. Mix together remaining ingredients and fill cavities of squash. Place in baking dish with filled side up. Continue cooking according to guidelines until filling is done.

Guidelines at a Glance

PREHEAT	TEMP	FAN SPEED	TIME	RACK USE	YIELD
1. YES	375°	HIGH	15-20 MIN.		
2. NO	375°	LOW	12-15 MIN.		2

STUFFED PEPPERS

- 2 large green peppers, cut in half lengthwise and remove seeds**
- 2 cups rice, cooked**
- ⅔ cup cheese, grated**
- ¼ cup onion, minced**
- 2 teaspoons chopped chives or pimento (optional)**
- Salt and pepper to taste**
- Cheese slices (optional)**

Blanch peppers in boiling water or in microwave oven for 1-2 minutes for more tender pepper shells. Mix together remaining ingredients, except for cheese slices. Stuff pepper shells and place directly on rack.

Bake according to guidelines. Top with cheese slices, if desired, during last minute of baking.

Guidelines at a Glance

PREHEAT	TEMP	FAN SPEED	TIME	RACK USE	YIELD
YES	375°	LOW	10-12 MIN.		4

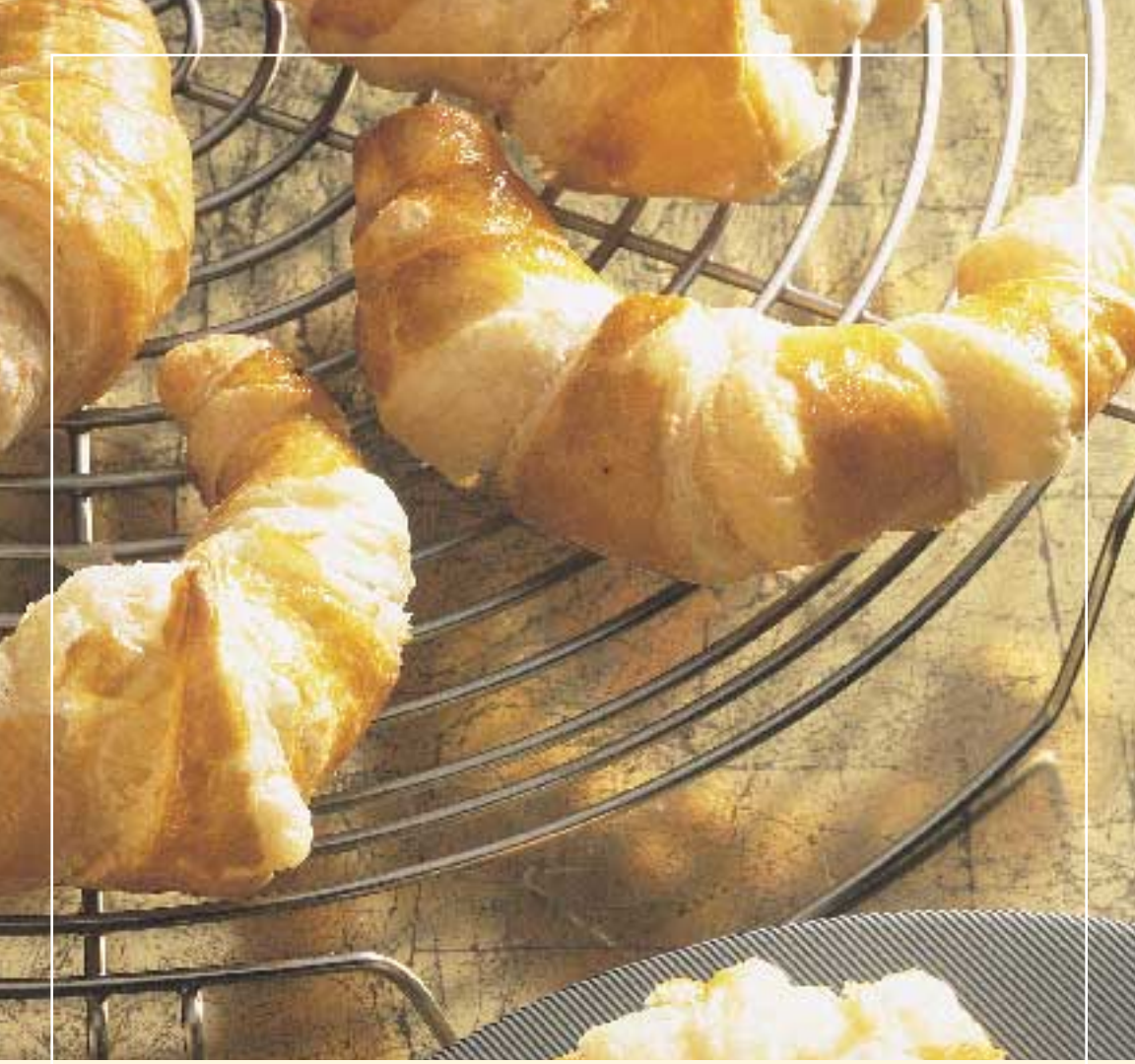

BAKED GOODS

When baking, the Jet-Stream Oven™ combines the best of both worlds. It provides the browning capabilities of a conventional oven and the shortened time of a microwave oven. Fresh dough products are especially well suited and raise higher than they would in your oven! The circular motion of “Cyclonic Cooking™” creates an air flow which actually pulls the dough upward causing the increase in volume.

Because of the very short cooking times, it is best *not* to preheat the oven and use LOW fan when baking so that a crust does not form too quickly. This will allow optimum rising and inhibit the surface from becoming too brown while the interior reaches the desired consistency. Use HIGH fan last 5 minutes if more browning is needed.

ALMOND CROISSANTS

- 1 sheet frozen puff pastry, thawed**
(from 17¼ oz. pkg.)
- 2 tablespoons sugar**
- 2 tablespoons water**
- ¼ cup ground almonds**
- ½ teaspoon almond extract**
- 1 egg yolk, beaten**

Cook sugar and water in small saucepan until syrupy. Remove from heat and stir in almonds and almond extract; cool. Roll out puff pastry to a 6 x 12 inch rectangle and cut into 16 triangles. Spread filling on triangles. Roll up from long sides and shape into crescents. Place on rack coated with no-stick spray. Brush with egg yolk and bake 8 minutes. Turn fan speed to high and bake 2-4 minutes longer, until golden brown.

Guidelines at a Glance

PREHEAT	TEMP	FAN SPEED	TIME	RACK USE	YIELD
YES	400°	LOW	10-12 MIN.		4

PECAN SANDIES

- 1 ⅓ cup all-purpose flour**
- ⅔ cup pecans, finely chopped**
- ½ cup margarine or butter, softened**
- ¼ cup confectioners sugar**
- 2 teaspoons ice water**
- ¾ teaspoon vanilla**
- Confectioners sugar for coating cookies**

Combine all ingredients except confectioners sugar for coating. Shape dough into 1 inch balls. Place 12 on ungreased

pizza pan or foil wrapped rack; flatten to ¼ inch thickness.

Bake according to guidelines until lightly browned. Let cool 3-4 minutes before removing from pan; coat with confectioners sugar. Bake second batch.

Guidelines at a Glance

PREHEAT	TEMP	FAN SPEED	TIME	RACK USE	YIELD
NO	350°	LOW	7-9 MIN.		24

ALMOND COOKIES

- ½ cup slivered, blanched almonds**
- 1 cup all-purpose flour, sifted**
- ½ cup margarine or butter**
- ½ cup sugar**
- ½ teaspoon almond extract**
- 24 whole blanched almonds**

Finely chop slivered almonds and mix with flour in a bowl.

In a separate bowl cream margarine or butter, sugar and almond extract until fluffy; slowly stir in flour mixture. Shape dough into 1 inch balls. Place 12 of the balls on 12 inch pizza pan or foil wrapped rack; flatten to ½ inch thickness. Press an almond into center of each cookie.

Bake according to guidelines until lightly browned. Let cool 2-3 minutes before removing from pan. Bake second batch.

Guidelines at a Glance

PREHEAT	TEMP	FAN SPEED	TIME	RACK USE	YIELD
NO	375°	LOW	6-8 MIN.		24



Chocolate Chip Cookies

CHOCOLATE CHIP COOKIES

- 2 $\frac{1}{4}$ cups all-purpose flour**
- 1 teaspoon baking soda**
- 1 cup margarine or butter, softened**
- $\frac{3}{4}$ cup firmly packed brown sugar**
- $\frac{1}{4}$ cup sugar**
- 3 $\frac{1}{2}$ oz. pkg. vanilla instant pudding pie filling mix**
- 1 teaspoon vanilla**
- 2 eggs**
- 12 oz. pkg. chocolate chips**

Combine flour and baking soda. Cream together margarine, sugars, pudding mix and vanilla until smooth; beat in eggs. Gradually stir in flour mixture. Stir in chocolate chips. Drop dough by rounded teaspoonfuls onto baking sheet; flatten slightly leaving a 1 inch space between cookies. Bake according to guidelines. Repeat with remaining dough.

Guidelines at a Glance[®]

PREHEAT	TEMP	FAN SPEED	TIME	RACK USE	YIELD
NO	375°	LOW	3-5 MIN.		6 doz.

EASY JET-STREAM OVEN BREAD

2 ½ teaspoons fast-acting yeast

room temperature

¼ cup warm water (110°F)

1½ cups warm milk (110°F)

½ cup warm water (110°F)

4 tablespoons sugar

2 tablespoons cooking oil

1 tablespoon salt

5 ¾-6 ½ cups bread flour

(not all-purpose flour)*

Dissolve yeast in ¼ cup warm water. Combine mixture with milk, ½ cup water, sugar, oil and salt. Add 3 cups flour and beat well; add enough additional flour to form a moderately stiff dough.



Turn out on lightly floured surface and knead until smooth, 10-12 minutes; dough will be soft. Shape into ball, place in lightly greased bowl, cover and set in warm place. Let rise until doubled, approximately 30-45 minutes. Cut dough into two pieces; shape into loaves and place in two 8 ½ x 4 ½ x 2 ½ inch greased bread pans.

Assemble Jet-Stream Oven with one expander ring. Preheat oven for 2 ½ minutes. Turn off fan and quickly set pans in oven; close lid. Let loaves rise until almost doubled, 15-20 minutes. Bake for 10-14 minutes**according to guidelines until top and sides of loaves are well browned. Cool for 10 minutes before cutting.

*Desired quality and texture require the use of bread flour

** Cooking time may vary due to altitude, humidity and/or electrical power.

Guidelines at a Glance®

PREHEAT	TEMP	FAN SPEED	TIME	RACK USE	YIELD
1. YES	OFF	OFF	15-20 MIN.		
2. NO	350°	LOW	10-14 MIN.		2

LEMON FILLED OATMEAL BARS

Crust

¾ cup quick cooking oats

¾ cup whole wheat flour

⅓ cup brown sugar

⅛ teaspoon salt

½ cup margarine or butter

Filling

1(8 oz.) package cream cheese

⅓ cup sugar

1 egg, beaten



1 tablespoon lemon juice

1 teaspoon grated lemon rind

Step 1. Prepare crust; Mix together dry ingredients. Cut in margarine or butter with fork to form crumbs; reserve ½ cup. Press remaining crumbs into an 8 x 8 inch pan. Bake according to guidelines or until lightly browned.

Step 2. Prepare filling: Soften cream cheese. Beat in remaining ingredients. Spread base with lemon filling and sprinkle with remaining crumbs. Continue baking according to guidelines until filling is set. Cool and cut into bars.

Guidelines at a Glance®

PREHEAT	TEMP	FAN SPEED	TIME	RACK USE	YIELD
1. NO	375°	LOW	4-6 MIN.		
2. NO	375°	LOW	7-9 MIN.		9-12

LEMON CRISPS

- 1/2 cup shortening
- 1/2 cup sugar
- 1 egg
- 1 tablespoon milk
- 1 teaspoon lemon extract
- 1 teaspoon vinegar
- 1 3/4 cup all-purpose flour
- 3/4 teaspoon baking soda
- 1/8 teaspoon salt

Mix together shortening, sugar and egg until well blended. Stir in milk, lemon extract and vinegar. Sift together flour, baking soda and salt. Stir into sugar mixture until stiff dough forms. Roll into 1 1/2 inch balls. Place 12 of them on a 12 inch ungreased pizza pan or foil wrapped rack and press with fork dipped in flour.

Bake according to guidelines until lightly browned. Let cool slightly before removing from pan. Bake second batch.

Guidelines at a Glance

PREHEAT	TEMP	FAN SPEED	TIME	RACK USE	YIELD
NO	400°	LOW	5-6 MIN.		24

NUT CRUNCHES

- 3/4 cup brown sugar
- 1/2 cup margarine or butter
- 1 egg
- 1 teaspoon vanilla
- 1 3/4 cup all-purpose flour
- 1/2 teaspoon baking soda
- 1/8 teaspoon salt
- 1/3 cup finely chopped pecans or walnuts

Mix together brown sugar, margarine or butter, egg and vanilla until well blended. Sift together flour, baking soda and salt; stir into sugar mixture along with nuts until stiff dough forms. Roll into 1 1/2 inch balls. Place 12 of them on 12 inch ungreased pizza pan or foil wrapped rack and flatten with bottom of greased glass dipped in sugar.

Bake according to guidelines until lightly browned. Let cool slightly before removing from pan. Bake second batch.

Guidelines at a Glance

PREHEAT	TEMP	FAN SPEED	TIME	RACK USE	YIELD
NO	375°	LOW	5-6 MIN.		24

Do you have a favorite recipe you'd like to share?
Enter it on our web site at www.nesco.com



BAKED APPLES

4 Granny Smith or other baking apples

4 tablespoons brown sugar

4 teaspoons margarine or butter

Cinnamon

½ cup apple juice or water

Core apples. Fill centers with brown sugar. Top with margarine or butter and sprinkle with cinnamon. Place in baking dish; pour in apple juice or water.

Bake according to guidelines until tender.

BAKED APPLES WITH ORANGE STUFFING

4 med. baking apples

¼ cup orange marmalade

¼ cup chopped almonds

2 tablespoons orange juice

4 teaspoons margarine or butter, softened

⅛ teaspoon cinnamon

⅛ teaspoon ginger

2 tablespoons sliced almonds

Wash and core apples; place in shallow baking dish. Combine orange marmalade, chopped almonds, orange juice, margarine or butter, cinnamon and ginger; stuff apples. Spread remaining mixture on top of apples and cover with sliced almonds; press gently. Bake according to guidelines until tender.

Guidelines at a Glance

PREHEAT	TEMP	FAN SPEED	TIME	RACK USE	YIELD
YES	400°	LOW	13-15 MIN.		4



Baked Apples with Orange Stuffing

CARAMEL RING

1 pkg. Wixon caramel roll mix

1 yeast packet

3/4 cup warm water

1 tablespoon sugar

1 tablespoon cinnamon

Sauce

1 pkg. sauce mix

1 tablespoon plus 1 teaspoon water

3/4 cup melted margarine or butter

8 pecan halves

8 cherry halves

Assemble Jet-Stream Oven with 1 Expander Ring. Dissolve yeast in warm water; stir in roll mix until dough begins pulling from sides of bowl. Place on floured surface and knead for 10-12 minutes. Place in greased bowl and cover. Let stand in warm place until doubled in size. Spray 6 cup tube pan with no-stick spray.

In a small bowl, mix sauce packet with water until dissolved, add melted margarine or butter. Pour sauce into tube pan. Arrange pecan and cherry halves over sauce mixture. Place dough on lightly greased surface and roll into a 16 x 10 inch rectangle. Sprinkle with sugar and cinnamon. Roll up jelly-roll style; pinch edge to seal. Cut into 16 one inch slices. Stand 10 slices in pan with cut sides against the outside. Stand remaining 6 slices around inside of pan. Cover and let rise until doubled in size.

Place caramel ring in Jet-Stream Oven and bake according to guidelines.

Guidelines at a Glance™

PREHEAT	TEMP	FAN SPEED	TIME	RACK USE	YIELD
YES	400°	HIGH	12-15 MIN.		16

FRUIT TARTS

10 oz. (pkg of 6) frozen puff pastry shells, thawed

21 oz. can prepared pie filling, any flavor

Roll each puff pastry shell to about a 5" circle. Top each with 1/3 cup pie filling. Bake 3 at a time according to guidelines, until golden brown. Repeat with remaining 3 pastries. Sprinkle with confectioners sugar and serve.

Guidelines at a Glance™

PREHEAT	TEMP	FAN SPEED	TIME	RACK USE	YIELD
NO	375°	LOW	10-12 MIN.		6

PINEAPPLE MINI MUFFINS

9 oz. pkg. cake mix, yellow or white

1/2 cup drained crushed pineapple

1 egg

Beat together all ingredients. Fill greased mini muffin pans 3/4 full. Bake according to guidelines one pan at a time.

Guidelines at a Glance™

PREHEAT	TEMP	FAN SPEED	TIME	RACK USE	YIELD
NO	350°	LOW	7-9 MIN.		24



Carmel Ring

PEANUT BUTTER MERINGUES

- 1 egg white**
- ½ cup of crunchy peanut butter**
- ⅓ cup sugar**
- ¼ teaspoon almond extract**

Beat egg white until stiff; fold in peanut butter, sugar and almond extract. Drop by teaspoonfuls onto greased foil wrapped rack.

Bake according to guidelines until lightly browned. Let stand 8-10 minutes before

removing from rack.

Note: Meringues will puff as they bake and then fall a little.

Guidelines at a Glance®

PREHEAT	TEMP	FAN SPEED	TIME	RACK USE	YIELD
NO	300°	LOW	11-12 MIN.		18





BAKED PINEAPPLE SLICES

4 pineapple slices

4 teaspoons red currant or raspberry jam

3 egg whites

1/4 teaspoon lemon juice

1/4 cup sugar

2 tablespoons flaked coconut

Spread pineapple slices with jam. Beat egg whites and lemon juice until foamy. Gradually beat in sugar until meringue is stiff and glossy; fold in coconut. Spread meringue over pineapple slices and bake according to guidelines until golden brown. Serve immediately.

Guidelines at a Glance

PREHEAT	TEMP	FAN SPEED	TIME	RACK USE	YIELD
YES	400°	LOW	7-8 MIN.		4

CREAM PUFFS

1 cup water

1/2 cup oil

1/4 teaspoon salt

1 cup all-purpose flour

4 large eggs, room temperature



Combine water, oil and salt in saucepan. Bring to a boil and remove from heat; immediately stir in flour. Let mixture cool 4-5 minutes; beat eggs in, one at a time. Mixture should be thick and shiny.

Step 1 & 2

Cover bottom rack with foil, shiny side down; secure by crimping edges. Drop mixture by spoonfuls onto rack. Cook according to guidelines (both steps) until golden brown and crisp. Cool. Fill with

chilled pudding or stuff with chicken or tuna salad for a luncheon entree.

Guidelines at a Glance

PREHEAT	TEMP	FAN SPEED	TIME	RACK USE	YIELD
1. YES	400°	LOW	10 MIN.		
2. NO	400°	HIGH	10-12 MIN.		14-18

APPLE STRUEDEL

2 cups peeled and chopped apples

(about 2 medium)

1/3 cup raisins

1/4 cup chopped walnuts

1/4 cup sugar

1/2 teaspoon cinnamon

4 sheets phyllo dough

3 tablespoons dry bread crumbs

Butter-flavor no-stick spray

Assemble Jet-Stream Oven with one Expander Ring. Combine apples, raisins, walnuts, sugar and cinnamon. Place 1 sheet phyllo dough on a large piece of plastic wrap. Spray lightly with no-stick spray and sprinkle with crumbs. Repeat with 3 remaining phyllo sheets. Spread apple mixture along short side of dough. Using plastic wrap, lift and carefully roll in jellyroll fashion. Do not seal ends. Place seam side down on pizza pan or foil-covered rack. Spray top lightly with non stick spray. Bake according to guidelines.

Guidelines at a Glance

PREHEAT	TEMP	FAN SPEED	TIME	RACK USE	YIELD
NO	325°	HIGH	25-30 MIN.		6

FRUIT SHORTCAKE

- 1 ¼ cup buttermilk baking mix
- ¼ cup milk
- 2 tablespoons sugar
- 1 tablespoon margarine or butter, melted
- 2 cups sweetened fruit
- Whipped topping or cream (optional)

Mix together baking mix, milk, sugar and margarine or butter. Divide into four parts. Sprinkle with extra baking mix and shape each part into a ½ inch circle. Place on 12 inch pizza pan or foil wrapped rack.

Bake according to guidelines until golden brown. Cool. Split each shortcake in half. Place fruit on bottom half of shortcake. Add top of shortcake and spoon on whipped cream.

Guidelines at a Glance

PREHEAT	TEMP	FAN SPEED	TIME	RACK USE	YIELD
NO	400°	LOW	6-8 MIN.		4

STRAWBERRY PIE

- 1 (8 or 9 inch) pie shell
- 1 (3 ⅛ oz) pkg. vanilla pudding and pie filling, cooked according to package directions using 1 ¾ cup milk
- 2 cups fresh strawberries, cut in half
- Strawberry glaze

Glaze

- 1 (10 oz) pkg. frozen sliced strawberries
- 1 tablespoon cornstarch
- ¼ cup strawberry jelly

Place pie shell directly on rack and bake according to guidelines. Prick well with fork after after 1 minute.

Prepare glaze: Thaw and crush strawberries in saucepan. Stir in cornstarch and jelly and bring to a boil. Cook and stir until thick and clear. Strain and cool.

Assemble pie: Spread cooked and cooled pudding in bottom of pie crust. Top with strawberries. Carefully pour glaze over strawberries. Thoroughly chill pie.

Guidelines at a Glance

PREHEAT	TEMP	FAN SPEED	TIME	RACK USE	YIELD
NO	400°	LOW	5-6 MIN.		6-8

INDIVIDUAL BAKED ALASKAS













- 4 sponge cake cups
- 6 tablespoons strawberries, raspberries or blueberries
- 4 scoops of very hard vanilla ice cream
- 3 egg white beaten into very stiff meringue

Fill sponge cakes with berries and top with ice cream. Spread with meringue, except for bottom of cups, leaving no air spaces. Bake according to guidelines until meringue is lightly browned. Serve immediately.

Guidelines at a Glance

PREHEAT	TEMP	FAN SPEED	TIME	RACK USE	YIELD
YES	400°	LOW	2-3 MIN.		4-6

COOKING GUIDE FOR BAKED GOODS

ITEM	QTY.	PRE-HEAT	TEMP/SPEED	TIME	RACK USE	CONTAINER/ HELPFUL HINTS
Croutons (sliced bread cut into cubes)	2-3 slices	NO	200° Low	8-10 Min.		8 X 8 " pan stir after 5 min.
Drop Biscuits from mix	6-8	NO	400° LOW	6-8 Min.		8 X 8 " pan
Graham Cracker Crust	1 (8 or 9")	NO	375° Low	4-5 Min.		Pie plate
Frozen: Cheese Blintzes	4-6	NO	375° Low	8-10 Min.		brush w/ melted margarine
Escaloped Apples	12 oz.	NO	375° Low	10-13 Min.		Pkg. container*
Fully Baked Pie	1 (27 oz.)	NO	375° Low	14-17 Min.		Pkg. container*
Muffins	4	NO	375° Low	4-6 Min.		
Pie Crust (deep dish or regular)	1 (8 or 9")	NO	400° Low	5-6 Min.		Pkg. container* prick w/ fork
Puff Pastry Shells	4-6	NO	1. 400° Low 2. 400° Low	9-11 Min. 2-3 Min.		8 X 8 " pan remove centers after step 1
Refrigerated: Biscuits	5 10	NO NO	400° Low 400° Low	4-6 Min. 6-8 Min.		
Cinnamon Rolls	5-8	NO	375° Low	6-8 Min.		Spread w/ icing
Cookie Dough	10-12 cookies	NO	375° Low	5-8 Min.		Pizza Pan or foil-wrapped rack
Soft Bread Sticks	5	NO	375° Low	5-8 Min.		

Unless otherwise specified, when two racks are shown in a recipe, food should be contained or sandwiched between the top and bottom racks.

* Many packaged food items come in a cooking container, this container is perfectly safe to use in the Jet-Stream Oven.™



QUICK COMBOS

Perhaps one of the most exciting features of the Jet-Stream Oven™ is its ability to prepare an entire meal, at one time in one container! It is possible, for example, to cook chicken, potatoes, and bread together without flavor mixing! When finished, instead of cleaning 3 containers, you simply disassemble the unit, remove the powerhead and place your Jet-Stream Oven in the dishwasher.

There are innumerable combinations of Quick Combos meals left only unto the imagination. We've assembled some ideas from the recipes and foods in this book to get your creative juices going. Experiment with your favorite foods using the times and temperatures listed for similar items in this manual as a guide.

BURRITOS

6 (10 inch) flour tortillas

1 small onion, chopped

1 tablespoon cooking oil

1 (15-16 oz.) can refried beans

1 ½ cup cheddar cheese, shredded

Bottled salsa

Canned Mexican cheese sauce, sour cream or quacamole (optional)



Step 1. Wrap stack of tortillas tightly in foil, place directly on rack and heat according to guidelines until tortillas are soft and flexible.

In saucepan, sauté onion in oil until tender but not brown. Stir in refried beans; cook until heated through. Spoon ⅓ cup bean mixture onto each tortilla.

Top with ¼ cup cheese and a heaping tablespoon of salsa. Fold one edge over filling, then fold two sides envelope fashion and then fold last side. Secure with toothpicks. Place seam side up on rack.

Step 2. Bake according to guidelines until nicely browned. Serve with heated cheese sauce, sour cream or guacamole.

Guidelines at a Glance™

PREHEAT	TEMP	FAN SPEED	TIME	RACK USE	YIELD
1. NO	375°	LOW	4-5 MIN.		
2. NO	375°	LOW	12-15 MIN.		6

PEANUT CRUSTED FISH STRIPS WITH DILLED CARROTS

1 lb. fish, cut into 1" wide strips

¾ cup fresh bread crumbs

⅓ cup unsalted peanuts, finely chopped

2 egg whites, well beaten

1 tablespoon oil

Salt and pepper to taste

Combine egg whites and oil in a flat dish. Combine crumbs, peanuts, salt and pepper in second dish. Dip fish strips in egg mixture and then coat with crumb mixture. Place on top rack and cook according to guidelines.

2 cups grated carrots, about ½ lb.

1-2 tablespoons melted margarine



1 teaspoon dill weed

Combine ingredients and divide between two sheets of foil. Twist and seal foil into pouches and flatten to about 1". Place on bottom rack and bake according to guidelines.

Step 1. Place carrot pouches on bottom rack and bake according to guidelines.

Step 2. Add fish strips to top rack and cook according to guidelines.

Guidelines at a Glance™

PREHEAT	TEMP	FAN SPEED	TIME	RACK USE	YIELD
1. YES	400°	HIGH	5 MIN.		
2. NO	400°	LOW	5-6 MIN.		4



BAKED TUNA CROQUETTES WITH HASHBROWN PATTIES

1 (7 oz.) can tuna, drained

1 egg

½ cup bread crumbs

2 tablespoons milk

1 tablespoon onion, grated

1 teaspoon lemon juice

Salt and pepper to taste

4 frozen hashbrown potato
patties

Margarine or butter



4-8 brown and serve rolls

Combine all ingredients, mix well. Divide evenly into 4 well-greased custard cups. Place cups on rack and add 4 frozen hashbrown potato patties, spread with margarine or butter.

Step 1. Bake according to guidelines until well browned.

Step 2. Place rolls around edge of top rack. Add to bottom rack and continue cooking according to guidelines until rolls are browned.

Guidelines at a Glance

PREHEAT	TEMP	FAN SPEED	TIME	RACK USE	YIELD
1. NO	400°	LOW	13-16 MIN.		
2. NO	400°	LOW	2-3 MIN.		4



COUNTRY STYLE SAUSAGE WITH SWEET POTATO BALLS

1 (¾-1 lb) beef smoked sausage
ring, fully cooked

3 medium sweet potatoes, peeled cooked
and mashed or 1 (18 oz) can vacuum
packed sweet potatoes, mashed

⅓ cup brown sugar

3 tablespoons margarine or butter,
melted

½ teaspoon cinnamon or nutmeg

Pecan or walnut halves



4-8 brown and serve rolls

Cut sausage into 4 pieces and cut each piece in half lengthwise. Mix together sweet potatoes, brown sugar, margarine or butter and spice. Shape into 8 balls. Place in a greased 8 or 9 inch aluminum pie plate. Press 3 nut halves into top of each sweet potato ball. Place pie plate in center of rack. Surround with sausage pieces.

Step 1. Cook according to guidelines until lightly browned and heated through.

Step 2. Place rolls around edge of top rack. Place top rack over bottom rack and continue cooking according to guidelines until potatoes and rolls are light-

Guidelines at a Glance

PREHEAT	TEMP	FAN SPEED	TIME	RACK USE	YIELD
1. NO	375°	LOW	10-13 MIN.		
2. NO	375°	LOW	2-3 MIN.		4

ly browned and heated through.

ITALIAN SAUSAGE DINNER



4 (4 oz) Italian sausages, pierce skins

4 vegetable kabobs (see page 37)

Step 1. Place sausages directly on rack. Cook according to guidelines.

Step 2. Add vegetable kabobs to rack and continue cooking according to guidelines until sausages are browned.

Guidelines at a Glance

PREHEAT	TEMP	FAN SPEED	TIME	RACK USE	YIELD
1. YES	400°	LOW	5-6 MIN.		
2. NO	400°	HIGH	5-6 MIN.		4

CHICKEN WITH VEGETABLES AND CRESCENT ROLLS

2 (3 ¾ oz.) frozen chicken fillets



1 (8-10 oz.) frozen vegetable pouch

1 (pkg. of 4) refrigerated crescent rolls

Step 1. Pierce vegetable pouch on top. Place chicken and vegetable pouch on rack. Cook according to guidelines.

Step 2. Add rolls and continue cooking according to guidelines until rolls are nicely browned.

Guidelines at a Glance

PREHEAT	TEMP	FAN SPEED	TIME	RACK USE	YIELD
1. YES	375°	HIGH	9-10 MIN.		
2. NO	375°	LOW	2-3 MIN.		2

BROILED CHICKEN, ZUCCHINI AND BISCUITS

2 (5 oz) refrigerated, marinated, boneless chicken breasts

2 (3-4 oz) zucchini, each sliced in thirds lengthwise

2 tablespoons margarine or butter, melted or olive oil

Garlic salt



2 tablespoons grated Parmesan or Romano cheese

1 (can of 5) refrigerated biscuits

Step 1. Arrange chicken and zucchini slices around edge of rack. Brush zucchini with margarine, butter or oil and sprinkle with garlic salt and grated cheese. Cook according to guidelines.

Step 2. Add biscuits to center of rack and continue cooking according to guidelines until zucchini is tender and biscuits are browned.

Guidelines at a Glance

PREHEAT	TEMP	FAN SPEED	TIME	RACK USE	YIELD
1. NO	400°	HIGH	5 MIN.		
2. NO	400°	LOW	8-10 MIN.		2



BAKED PORK CHOPS WITH SPICED APPLES

4 Pork Chops

1 bag Shake n' bake

4 Granny Smith apples

Cinnamon & sugar

Shake pork chop in coating mix. Place chops on rack with the wide side toward the outer edge of rack.

Cut apples in half and remove core using a melon baller. Sprinkle apples with cinnamon mixture. Place apples on rack with pork chops and bake according to guidelines.

Guidelines at a Glance

PREHEAT	TEMP	FAN SPEED	TIME	RACK USE	YIELD
YES	400°	HIGH	10 MIN.		4

SMOKED PORK CHOPS, POTATOES AU GRATIN AND BISCUITS

2 (6-8 oz.) smoked pork chops



1 (11½ oz.) pkg. frozen potatoes au gratin

1 (can of 5) refrigerated biscuits

Step 1. Place pkg. of potatoes on rack. Cook according to guidelines; stir.

Step 2. Add pork chops and biscuits to rack and continue cooking according to guidelines until potatoes are done and biscuits are browned.

Guidelines at a Glance

PREHEAT	TEMP	FAN SPEED	TIME	RACK USE	YIELD
1. NO	375°	LOW	12 MIN.		
2. NO	375°	LOW	5-7 MIN.		2

EGG BREAKFAST

6-8 slices bacon or frozen microwave sausage patties or links



4 eggs in shell

4 frozen muffins or 1 (can of 5) refrigerated cinnamon rolls

Step 1. Place foods on rack. Cook according to guidelines. Remove meat and muffins or rolls.

Step 2. Continue cooking eggs according to guidelines for hard cooked eggs (or 1-2 minutes for medium cooked eggs).

Guidelines at a Glance

PREHEAT	TEMP	FAN SPEED	TIME	RACK USE	YIELD
1. YES	375°	LOW	7-8 MIN.		
2. NO	375°	LOW	2-3 MIN.		4

Do you have a favorite recipe you'd like to share?

Enter it on our web site at

www.nesco.com



LAMB CHOP SPECIAL

2 (8 oz.) shoulder lamb chops

Italian salad dressing

4 (1 ½- 2 inch diameter) new potatoes

Cooking oil

1 (8 oz.) can pear halves, drained



Mint jelly

2-4 brown and serve rolls

Step 1. Brush all sides of chops with Italian salad dressing; brush potatoes with cooking oil and place both chops and potatoes directly on rack. Cook according to guidelines.

Step 2. Place a teaspoon of mint jelly in center of each pear half; add to bottom rack. Put rolls around edge of top rack and place top rack over bottom rack and continue cooking according to guidelines until rolls are lightly browned.

Guidelines at a Glance

PREHEAT	TEMP	FAN SPEED	TIME	RACK USE	YIELD
1. NO	400°	LOW	12-16 MIN.		
2. NO	400°	LOW	3-4 MIN.		2

BROILED SALMON STEAKS WITH STUFFED PEPPERS

1 (6-8 oz.) salmon steaks

2 tablespoons margarine or butter, melted

½ teaspoon dill weed

2 stuffed peppers (½ of recipe on page 39)



1 (can of 5) refrigerated bread sticks

Brush salmon steaks with melted margarine and sprinkle with dill weed. Prepare peppers according to recipe. Place salmon and peppers on rack.

Step 1. Cook according to guidelines.

Step 2. Shape bread sticks into knots and place around edge of rack. Continue cooking according to guidelines until bread sticks are browned.

Guidelines at a Glance

PREHEAT	TEMP	FAN SPEED	TIME	RACK USE	YIELD
1. YES	375°	LOW	7-10 MIN.		
2. NO	375°	LOW	5-7 MIN.		2

BREAKFAST KABOBS

1 (7½ oz.) can of 10 refrigerated biscuits, cut into quarters

8 (1 oz.) sausage links, cut into thirds

2 med. apples, each cut into 12 pieces

3 tablespoons margarine or butter, melted

⅓ cup sugar combined with

½ teaspoon cinnamon

12-6 inch bamboo skewers

Thread biscuits, sausages and apples onto skewers. Brush skewers with margarine and roll in cinnamon-sugar. Place on rack and broil according to guidelines until biscuits are browned and apples are tender.

Guidelines at a Glance

PREHEAT	TEMP	FAN SPEED	TIME	RACK USE	YIELD
YES	400°	HIGH	5-6 MIN.		4

Appetizers/Snacks

Barbequed Shrimp.....	19
Cream Cheese Wontons.....	20
Crostini with Mozzarella.....	24
Egg Rolls.....	20
Frozen Appetizers.....	36
Grilled Cheese Tomato Rounds.....	23
Hot Shrimp Appetizers.....	22
Italian Artichoke Dip.....	22
Marinated Chicken Wings.....	23
Mini Franks.....	19
Mini Mexican Meatballs.....	19
Olive Cheese Snacks.....	25
Oriental Kabobs.....	20
Pizza Snacks.....	22
Rumaki.....	24
Salami Pinwheels.....	23
Spicy Chicken Drumettes.....	19
Spicy Pepper Snacks.....	25
Spinach Stuffed Mushrooms.....	25

Cooking Guide for Convenience Foods

Boneless Marinated Chicken Breasts.....	17
Battered Shrimp.....	17
Breaded Cheese Nuggets or Sticks.....	17
Breaded Chicken Patties.....	17
Breaded Fish Fillets.....	17
Buttered Fish Fillets.....	17
Chicken Fillets.....	17
French Bread Pizza.....	17
Fried Chicken.....	17
Frozen Egg Rolls.....	17
Microwave Sausage Patties/Links.....	17
Mini Quiches.....	17
Pizza.....	17
Pocket Sandwiches.....	17
Pot Pie.....	17
Sandwich Croissants.....	17

Waffles or French Toast.....	17
Wieners in Wraps.....	17

Entrees

Barbequed Baby Back Ribs.....	32
Barbequed Chicken.....	32
Beef and Pineapple Kabobs.....	36
Broiled Salmon.....	27
Chicken Cordon Bleu.....	30
Chinese Chicken Stir-fry.....	28
Cornmeal Battered Fish.....	34
Crab Cakes.....	30
Crispy Chicken Strips.....	31
Duckling L'Orange.....	28
Deluxe Breaded Fish.....	34
English Pastry.....	34
Honey-Mustard Chicken Legs.....	31
Italian Beef Stir-fry.....	33
Lemon Pepper Chicken.....	35
Mini Meatloaves.....	34
Mustard Rosemary Chicken.....	30
Oriental Beef Strips.....	35
Pork and Red Chili Stir-fry.....	29
Roasted Turkey Breast.....	31
Sausage Broccoli Roll-ups.....	27
Stromboli.....	33
Stuffed Cornish Game Hens.....	27
Stuffed Cheeseburgers.....	35
Shrimp Kabobs.....	35
Wienerschnitzel.....	33

Cooking Guide for Meats

Bacon.....	37
Chicken, Whole (w/ 1 Expander Ring).....	37
Chicken Breast w/ bone.....	37
Chicken Breast, Boneless.....	37
Cornish Game Hens.....	37

Eggs (in the shell).....	37
Fish Fillets in Coating Mix.....	37
Ground Beef Patties.....	37
Ground Turkey Patties.....	37
Ham Steak.....	37
Italian Sausage or Bratwurst.....	37
Pork Chops in Coating Mix.....	37
Salmon Steaks.....	37
Steak, T-Bone or Porterhouse.....	37
Turkey (w/ 2 Expander Rings).....	37

Vegetables

Breaded Cauliflower.....	42
Broiled Tomato Halves.....	42
Dilled Zucchini.....	39
Grilled Sweet Potatoes.....	39
Italian Eggplant.....	42
Italian Stuffed Tomatoes.....	41
Jet-Stream Potatoes.....	39
Orange Asparagus.....	41
Stuffed Acorn Squash.....	43
Stuffed Baked Potatoes.....	39
Stuffed Peppers.....	43
Stuffed Zucchini.....	43
Vegetable Kabobs.....	41

Cooking Guide for Vegetables

Acorn Squash (cut in half).....	40
Baked Potatoes.....	40
Frozen Baked Beans.....	40
Frozen Breaded Vegetables.....	40
Frozen Corn Soufflé.....	40
Frozen French Fries.....	40
Frozen Hashbrown Patties.....	40
Frozen Onion Rings.....	40
Frozen Potatoes au Gratin.....	40
Frozen Spinach Soufflé.....	40

Frozen Vegetable Lasagna.....	40
Frozen Vegetable Pouch.....	40
Zucchini (cut in half).....	40

Baked Goods

Almond Coissants.....	45
Almond Cookies.....	45
Apple Strudel.....	53
Baked Apples.....	49
Baked Apples w/ Orange Stuffing.....	49
Baked Pineapple Slices.....	53
Caramel Ring.....	50
Chocolate Chip Cookies.....	46
Cream Puffs.....	53
Easy Jet-Stream Oven Bread.....	47
Fruit Shortcake.....	54
Fruit Tarts.....	50
Individual Baked Alaskas.....	54
Lemon Crisps.....	48
Lemon Filled Oatmeal Bars.....	47
Nut Crunches.....	48
Peanut Butter Merigues.....	51
Pecan Sandies.....	45
Pineapple Mini Muffins.....	50
Strawberry Pie.....	54

Cooking Guide for Baked Goods

Croutons (sliced bread cut into cubes).....	55
Drop Biscuits from Mix.....	55
Graham Cracker Crust.....	55
Frozen Cheese Blintzes.....	55
Frozen Escalloped Apples.....	55
Frozen Fully Baked Pie.....	55
Frozen Muffins.....	55
Frozen Pie Crust (deep dish or regular).....	55

Frozen Puffed Pastry Shells.....	55
Refrigerated Biscuits.....	55
Refrigerated Cinnamon Rolls.....	55
Refrigerated Cookie Dough.....	55
Refrigerated Soft Bread Sticks.....	55

Quick Combos

Baked Pork Chops w/ Spiced Apples.....	60
Baked Tuna Croquettes w/ Hashbrown Patties.....	58
Breakfast Kabobs.....	61
Broiled Chicken, Zucchini & Biscuits.....	59
Broiled Salmon Steaks w/ Stuffed Peppers.....	61
Burritos.....	57
Chicken w/ Vegetables & Crescent Rolls.....	59
Country Style Sausage w/ Sweet Potato Balls.....	58
Egg Breakfast.....	60
Italian Sausage Dinner.....	59
Lamb Chop Special.....	61
Peanut Crusted Fish Strips w/ Dilled Carrots.....	57
Smoked Pork Chops, Potatoes Au Gratin & Biscuits.....	60



JET-STREAM OVEN™

Recipes & Instructions



1-800-288-4545
www.nesco.com

300-03501